

SuperTarzan™ MQ7260ASMT
Non-isolated 3~5.5VDC input, 0.75~3.6V output, 20A DC-DC Converter



Applications

- Workstations, servers
- Desktop computers
- DSP applications
- Distributed power architectures
- Telecommunications equipment
- Data communications equipment
- Wireless communications equipment

Features

- Wide operating voltage: 3V ~ 5.5V
- Output Current up to 20A
- Output voltage ripple: 20mV_{PP}
- High Efficiency 95%
- Overcurrent /shortcircuit protection
- Over-temperature protection
- Remote on/off control-positive logic
- High reliability: designed to meet 5 million hour MTBF
- Output voltage remote sense compensation ("s" suffix)
- Minimal space on PCB:
 - 33.02 mm x 13.46 mm x 6.9 mm or
 - 1.30 in x 0.53 in x 0.27 in
- No derating to +60°C, natural convection
- UL/IEC/EN60950 compliant
- RoHS Compliant available

Options

- Output voltage remote sense

Description

The **SuperTarzan™** MQ7260ASMT Series Power Modules are non-isolated dc-dc converters that operate over a wide input voltage range of 3Vdc to 5.5Vdc and provide a precisely (2%) regulated dc output with industry standard pin configuration. Such a module is suitable to application with 3.3V or 5V power supply bus. The modules have a maximum output current rating of 20A at a typical full-load efficiency over 95%. Standard features include remote on/off with positive logic and output voltage trimmable, over-current protection, over-temperature protection. Option features include output voltage remote sense compensation.

***** **Typical Application Circuit** *****

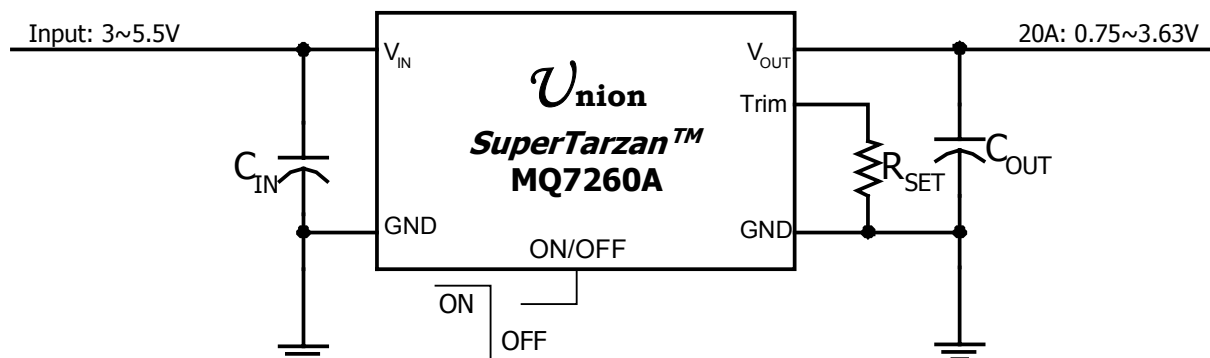

Performance Specifications (at TA=+25°C)

Model	Input V _{IN} Range (V)	Output				Efficiency (%)
		I _{OUT} (A)	Trim Range (V)	Regulation		
				Line (%)	Load (%)	
MQ7260ASMT	3.0~5.5	20	0.75V~3.6V	0.5	0.5	95

Mechanical Specifications

Dimensions are in mm (inches)

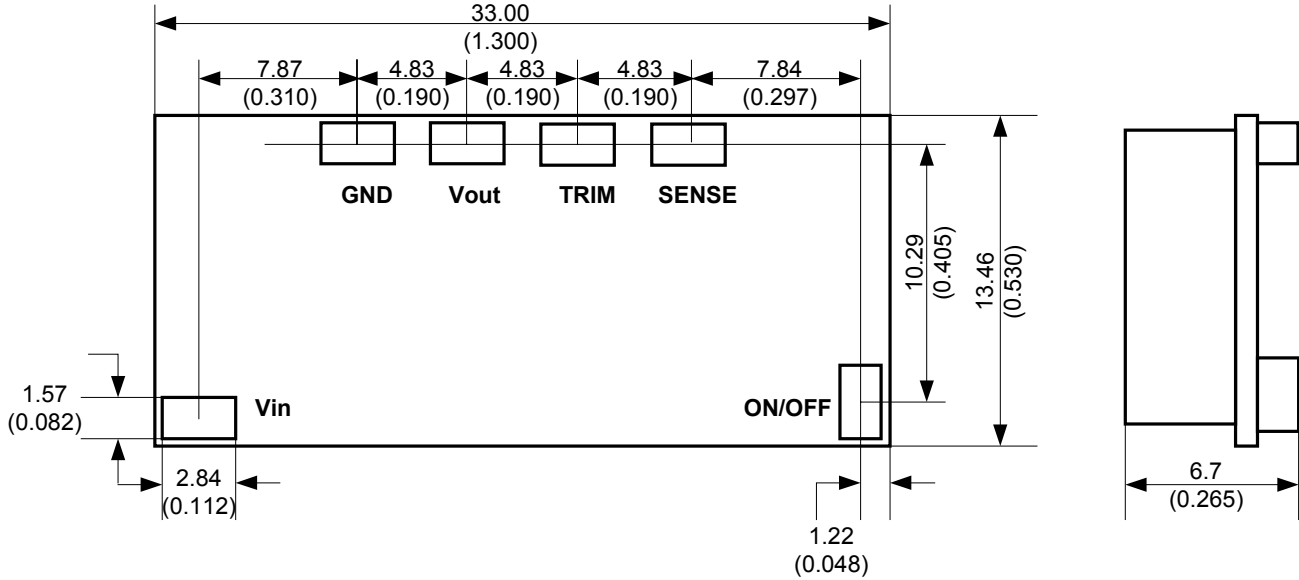

Ordering Information

MQ7260ASMT1abcdSPG

Union Microsystems
Power module P/N

SIP/SMT Package

Input Voltage Range:
1:3.0~5.5V
2:8~14V

Output Voltage:
9999: for adjustable version
abcd: a*10+b*1+c*0.1+d*0.01

Green Product
(RoHS Compliant)

P: Positive Logic

S: Remote Sense

X: Non-Remote Sense

For examples:

MQ7260ASMT10150SPG means MQ7260A in SMT package, input voltage 3.0~5.5V, output voltage 1.5V, with remote sense pin equipped, positive logic mode and green product.

MQ7260ASMT19999XPG means MQ7260A in SMT package, input voltage 3.0~5.5V, output voltage 0.75~3.6V, without remote sense pin equipped, positive logic mode and green product.

Absolute Maximum Ratings

Note: These are stress ratings. Exposure of devices to any of these conditions may adversely affect long-term reliability. Proper operation under conditions other than those listed in the Performance Specifications Table is not implied.

Parameter	Symbol	Min	Max	Unit
Input Voltage	V_{IN}	-0.3	6	V
Storage Temperature	T_{STG}	-40	125	°C

MQ7260ASMT Electrical Specifications: ($T_A=+25^{\circ}\text{C}$)

Parameter	Condition	Symbol	Min	Typ	Max	Unit
Input Voltage Range		V_{IN}	3.0		5.5	V
Output Current		I_o	0		20	A
Output Voltage Set point	100% load	ΔV_o	-2		+2	%
Output Trim Range	See Performance Specifications					
Line Regulation						
Load Regulation						
Output Ripple and Noise Voltage	$I_o=20\text{A}, 0\sim 20\text{MHz}$ (Detail Please see Ripple Figures, Page 10)					

General Specifications

Parameter	Condition	Symbol	Min	Typ	Max	Unit
Maximum Capacitive Load	20A resistive load + Aluminum capacitor			6600		μF
	20A resistive load +Sanyo POSCAP			2000		
Overcurrent Protection			24		40	A
Output short-circuit current (average)	All				2	A
Under Voltage Lockout Trip Level	Rising and falling V_{IN} , 3% hysteresis		1.95	2.05	2.15	V
Logic High (Module ON)		V_{IH}	2.8		6.5	V
Logic Low (Module OFF)		V_{IL}	-0.7		0.3	V
Start-up Time	6A resistive load, no external output capacitors			1		mS
Switching Frequency		F_o		300		KHz
Operating Temperature	Natural convection, no forced air flow (with derating of $0.5\text{W}/^{\circ}\text{C}$ when $T_A \cong +55^{\circ}\text{C}$)		-40		85	°C
Vibration	3 Axes, 5 Min Each	10~55Hz, 0.35mm, 5g				
	3 Axes, 6 Times Each	Peak Deviation 300g, Settling Time 6mS				
MTBF		5,000,000				Hour

Test Configurations

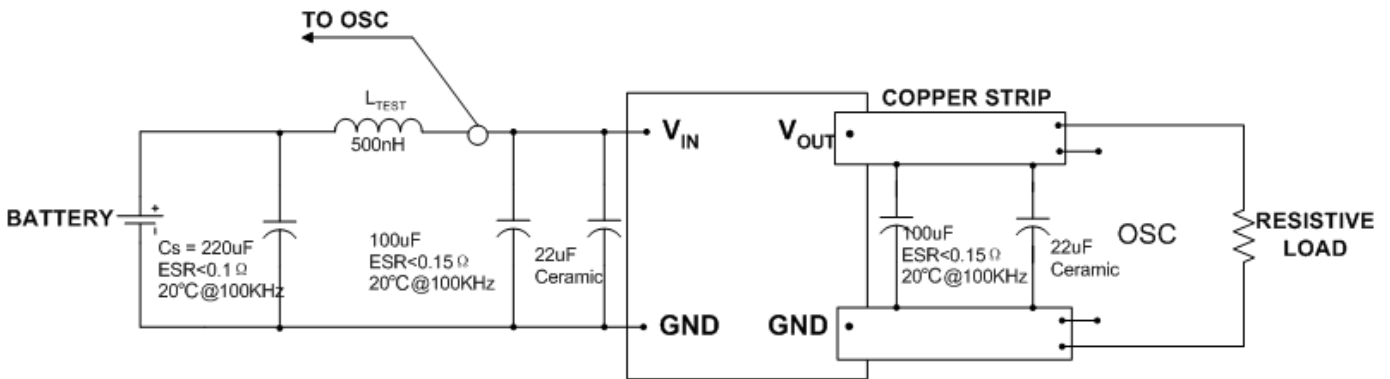

Test setup for input noise, output noise and ripple

Note:

Output noise is measured with 0.1µ F ceramic capacitor connected at the output. OSC measurement should be made using a BNC socket. Position the load between 50mm and 75mm (2in. and 3in) from the tested module.

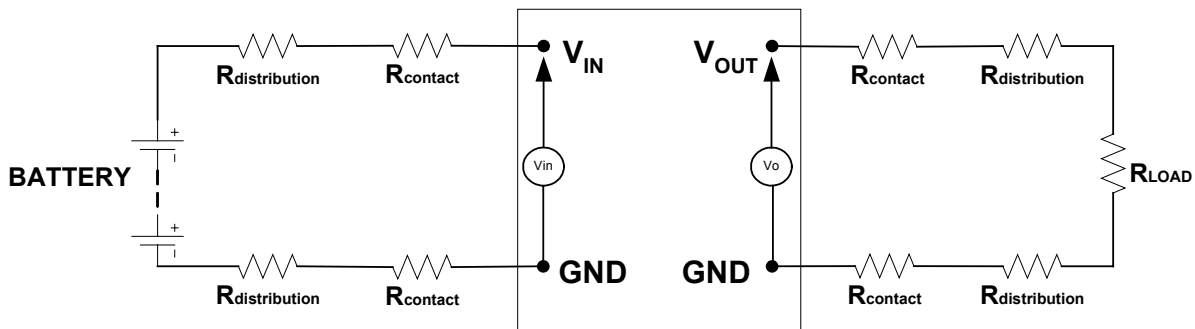

Test setup for efficiency

Note:

All voltage measurements must be taken at the module's terminals, as shown above. If sockets are needed, Kelvin connections are required at the module terminals to avoid measurement errors due to socket contact resistance.

Technical Notes

Input Voltage Range

The MQ7260ASMT Series can be used in a wide variety of applications, esp. most of 3.3V or 5V power supply bus system. So, when system voltage transferred from 5V to 3.3V or vice versa, no redesign needed which simplifies design, speeds the time to market and adds flexibility to system.

Return Current Paths

The MQ7260ASMT Series is non-isolated DC/DC converters. To the extent possible with the intent of minimizing ground loops, input return current should be directed through pin GND, and output return current should be directed through pin GND also.

I/O Filtering

All the specifications of the MQ7260ASMT Series are tested and specified without output capacitors. However, certain input capacitors are necessary to improve the power modules' operating conditions and to reduce the ac impedance. For example, under some conditions, the power modules can't normally start up when fully loaded due to the high ac-impedance input source. External input capacitors serve primarily as energy-storage devices. They should be added close to the input pins of the MQ7260ASMT and

selected for bulk capacitance (at appropriate frequencies), low ESR, and high rms-ripple-current ratings. All external capacitors should have appropriate voltage ratings. To reduce the amount of ripple current fed back to the input supply (input reflected-ripple current), an external L-C filter can be added with the inductance as close to the power module as possible.

MQ7260ASMT's output ripple and transient response can be improved with the increasing output capacitance. When using output capacitors, take care that the total output capacitance does not exceed MQ7260ASMT's Maximum Capacitive Load to avoid the module's protection condition in the start-up.

When an external L-C filter is added to reduce ripple on load, for best results, the filter components should be mounted close to the load circuit rather than the power module.

When testing the relationship between external capacitors and output voltage noise, the oscilloscope's probe should be applied to the module's end directly with scope probe ground less than 10mm in length.

Input Fusing

The MQ7260ASMT Series is not internally fused. Certain applications and/or safety agencies may require the installation of fuses at the inputs of power conversion components. The selection of the fuses should conform to the following:

1. The fuse value should be selected to be greater than the maximum input current of the module which occurs at the minimum input voltage.
2. Use either slow-blow or normal-blow fuses.
3. Both input traces must be capable of carrying a current of 1.5 times the value of the fuse without opening.

Safety Considerations

MQ7260ASMT's are non-isolated DC/DC converters. In general, all DC-DC's must be installed in compliance with relevant safety-agency specifications (usually UL/IEC/EN60950). In particular, for a non-isolated converter's output voltage to meet SELV (safety extra low voltage) requirements, its input must be SELV compliant. If the output needs to be ELV (extra low voltage), the input must be ELV.

Remote Sense

MQ7260ASMT Power Modules with suffix "S" offer an output sense function on pin 3. The sense function enables point-of-use regulation for overcoming moderate IR drops in conductors and/or cabling. The sense line carries very little current and consequently requires a minimal cross-sectional-area conductor. As such, it is not a low-impedance point and must be treated with care in layout and cabling. Sense lines should be run adjacent to signals (preferably ground).

Use of trim and sense functions can cause the output voltage to increase, thereby increasing output power beyond the MQ7260ASMT's specified rating. Therefore:

$$V_{OUT} \text{ (at pins)} \times I_{OUT} \leq P \text{ (rated output power)}$$

Note: If devices have the +Sense pin (pin3) installed and the sense function is not used for remote regulation, +Sense (pin3) must be tied to +Output (pin4) at the DC/DC converter pins.

ON/OFF Control

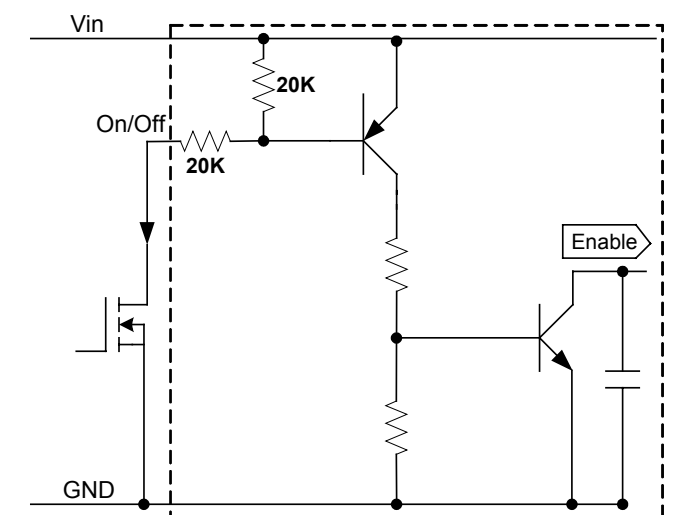

Fig1. Remote ON/OFF Implementation with pull-up pnp transistor

The MQ7260ASMT power modules feature an On/Off pin for remote On/Off operation. The Remote ON/OFF pin may be used

to turn on or turn off the regulator using a suitable open collector or open drain function. Turn off is achieved by connecting the Remote ON/OFF pin to ground. The regulator will run in normal operation when the RC pin is left open or tied to VIN directly.

Output Overvoltage Protection

MQ7260ASMT Series products do not incorporate output over voltage protection. If the operating circuit requires protection against abnormal output voltage, voltage-limiting circuitry must be provided external to the power module.

Output Overcurrent Protection (OCP)

MQ7260ASMT incorporates overcurrent and short circuit protection. If the load current exceeds the overcurrent protection setpoint, the MQ7260ASMT's internal overcurrent-protection circuitry immediately turns off the module, which then goes into Hiccup mode. The unit operates normally once the output current is brought back into its specified range. The typical average output current during hiccup is 1~2A.

Caution: Be careful never to operate MQ7260ASMT in a "heavy overload" condition that is between the rated output current and the overcurrent protection setpoint. This can cause permanent damage to the components.

Overtemperature Protection (OTP)

To ensure MQ7260ASMT's reliability and avoid damaging its internal components, MQ7260ASMT incorporates over-temperature protection circuit. When the temperature of the PCB is above 120°C, the overtemperature protection circuit will be enabled and the module will stop working. When the temperature of the temperature-testing component is below about 80°C, the overtemperature protection circuit will release and the module will automatically recover from shutdown. To avoid permanently damaging components, the surface temperature of MQ7260ASMT's power components, esp. of the MOSFET (T_{REF} in Fig2) should be ensured below 120°C.

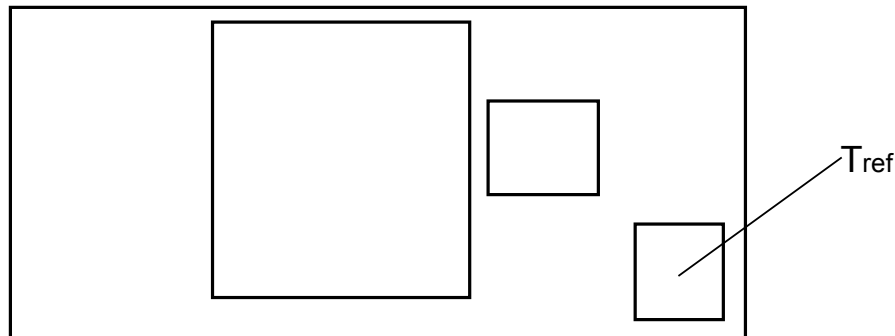

Fig2, Temperature Reference Point

Note: The overtemperature protection may be issued when MQ7260ASMT operates in a "heavy overload" condition for a long time. Thus, the air flow should be improved.

Output Voltage Trimming

MQ7260ASMT's output voltage can be trimmed in certain ranges. See Figure 3 for the 2 programming methods. See Performance Specifications for allowable trim ranges in detail. Also customized products are offered.

Trim with external resistor (Fig3a), the equation as below:

$$R_{TRIM} = \frac{21070}{V_O - 0.7525} - 5110$$

Resistor values are in Ω ; V_O is desired output voltage.

For examples, to trim output to 1.5V, then

$$R_{TRIM} = \frac{21070}{1.5 - 0.7525} - 5110 = 23077$$

So, $R_{TRIM} = 23.077k\Omega$

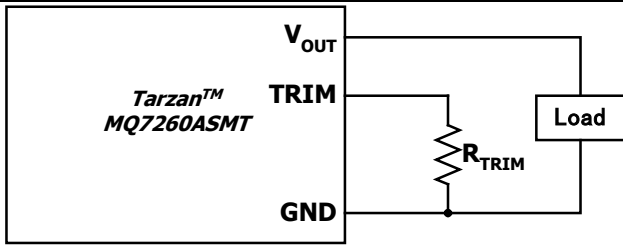

Fig3a. Circuit configuration for programming output voltage using external resistor

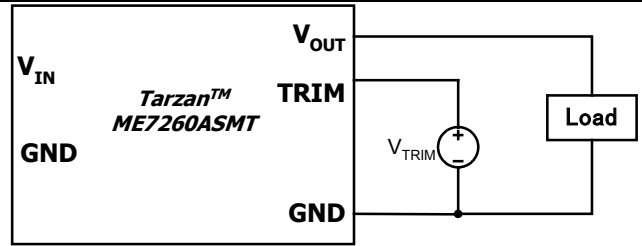

Fig3b. Circuit configuration for programming output voltage using external voltage source

Fig3, Program output voltage by external resistor or voltage source

And the voltage can be programmed by using an external voltage source (Fig3b), the equation as below:

$$V_{TRIM} = 0.7 - 0.1698 \times (V_O - 0.7525)$$

V_{TRIM} values are in Volt; V_O is desired output voltage.

For examples to trim output to 1.5V, then

$$V_{TRIM} = 0.7 - 0.1698 \times (1.5 - 0.7525) = 0.5731$$

So, $V_{TRIM} = 0.5731V$

For most common voltages, the required Trim resistors and voltages as Table 1.

Table 1, the required trim resistors R_{TRIM} and Trim voltages V_{TRIM} for most common voltages

Desired Voltages (V)	R_{TRIM} (k Ω)	V_{TRIM} (V)
0.7525	OPEN	OPEN
1.0	85.126	0.6580
1.2	41.973	0.6240
1.5	23.077	0.5731
1.8	15.004	0.5221
2.5	6.947	0.4033
3.3	3.160	0.2670

Typical Characteristics – output adjusted to 1V

General conditions:

Input filter 22µF Ceramic + 100µF TAN (150mΩ ESR), Output filter 22µF Ceramic + 100µF TAN (150mΩ ESR)

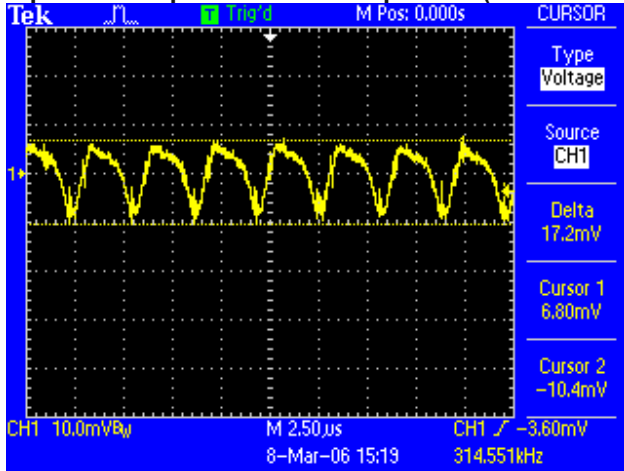

Noise $V_{IN}=5V$, $I_O=20A$, 5~20MHz Bandwidth

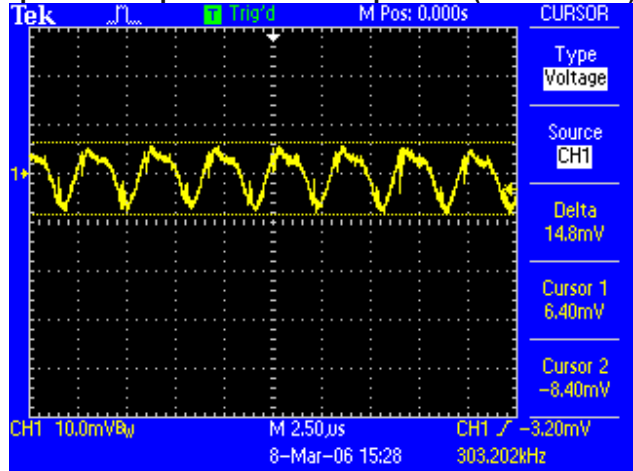

Noise $V_{IN}=3.3V$, $I_O=20A$, 5~20MHz Bandwidth

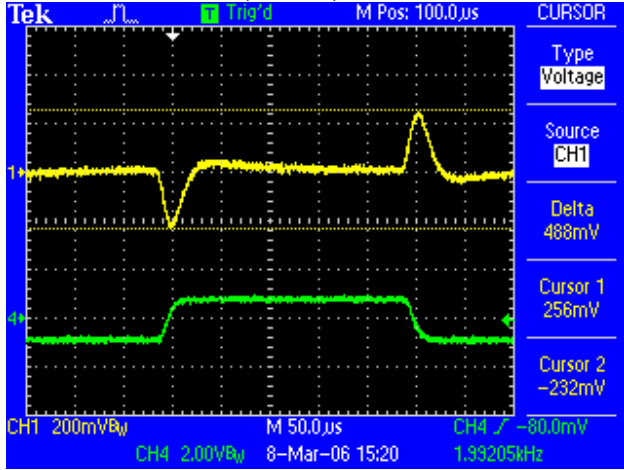

Transient Response $V_{IN}=5V$, Step from 10A~20A~10A

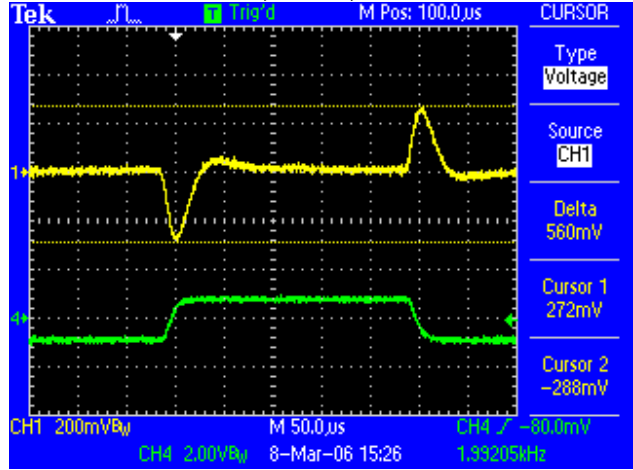

Transient Response $V_{IN}=3.3V$, Step from 10A~20A~10A

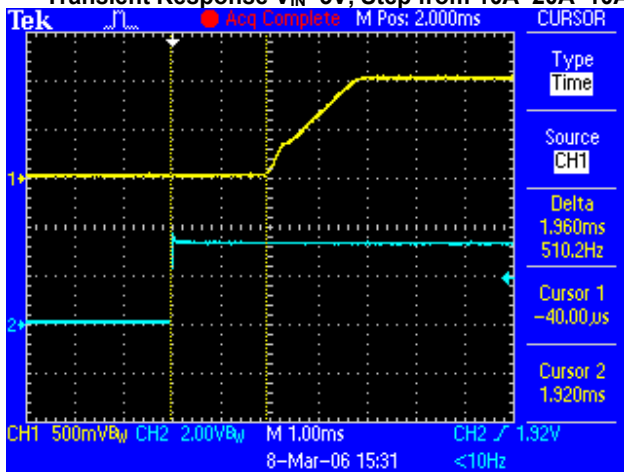

Start-up $V_{IN}=3.3V$, $I_O=15.6A$ (resistive load)

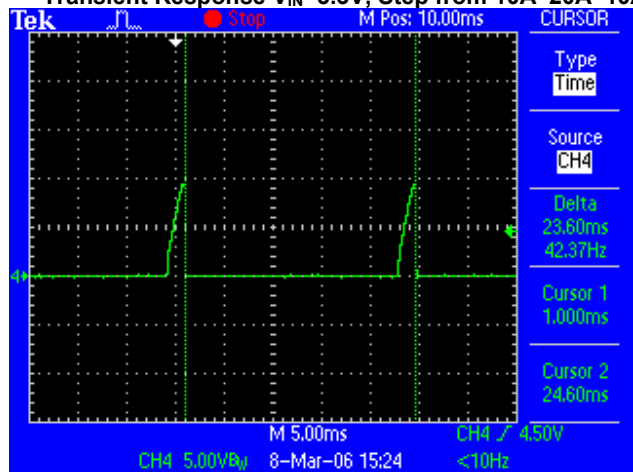

Short-Circuit Output $V_{IN}=3.3V$ (CH4: 30A/Div)

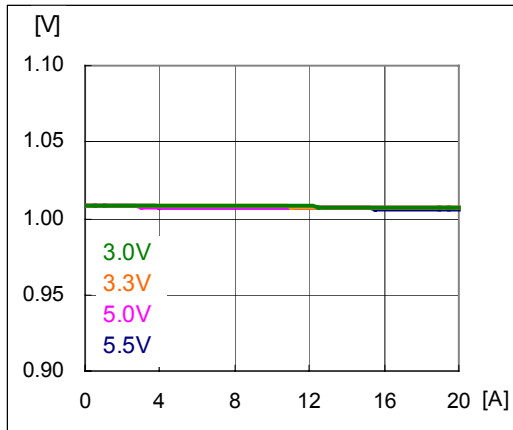

Regulation
Output voltage vs. Load Current,

Output Current Derating (Load Current vs. Ambient Temperature (T_{REF} , See Page 6)), $V_{IN}=5V$,

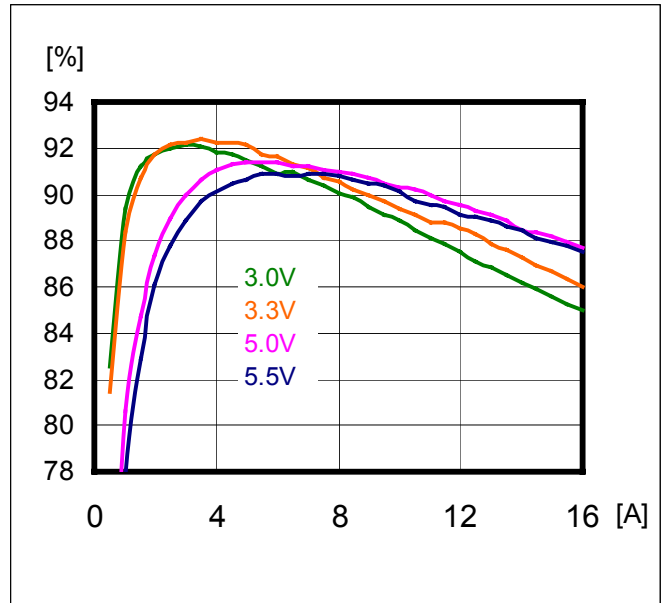

Efficiency

Output Current Derating (Load Current vs. Ambient Temperature (T_{REF} , See Page 6)), $V_{IN}=3.3V$

Typical Characteristics – output adjusted to 1.2V

General conditions:

Input filter 22µF Ceramic + 100µF TAN (150mΩ ESR), Output filter 22µF Ceramic + 100µF TAN (150mΩ ESR)

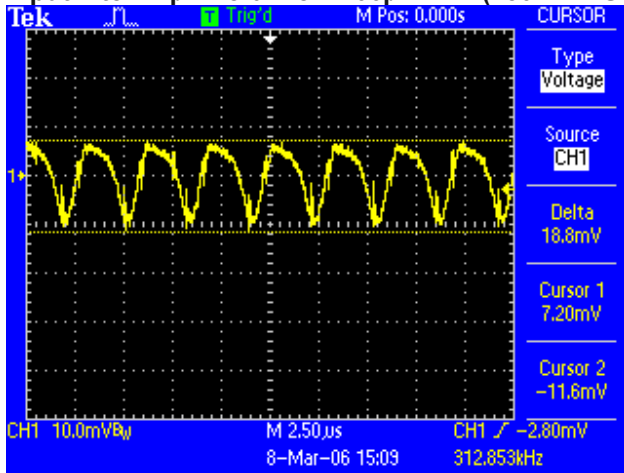

Noise $V_{IN}=5V$, $I_O=20A$, 5~20MHz Bandwidth

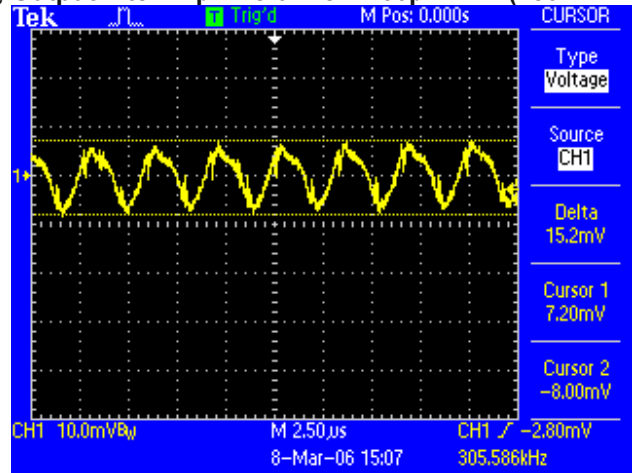

Noise $V_{IN}=3.3V$, $I_O=20A$, 5~20MHz Bandwidth

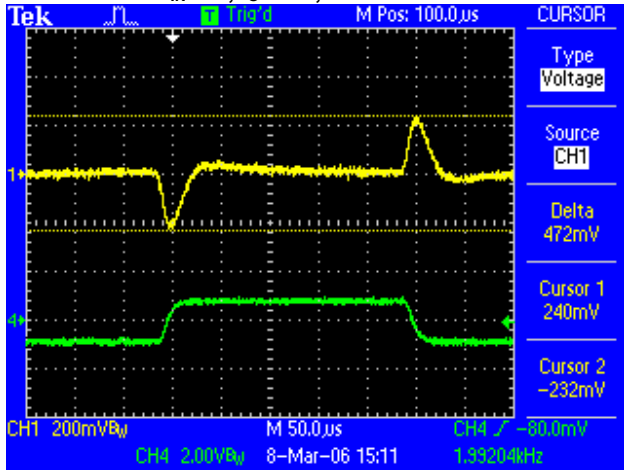

Transient Response $V_{IN}=5V$, Step from 10A~20A~10A

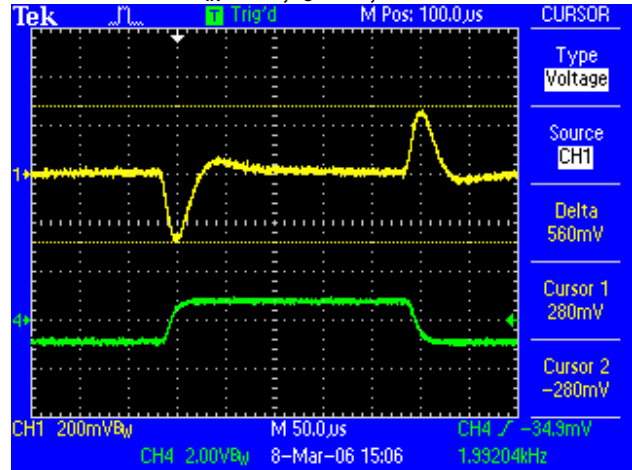

Transient Response $V_{IN}=3.3V$, Step from 10A~20A~10A

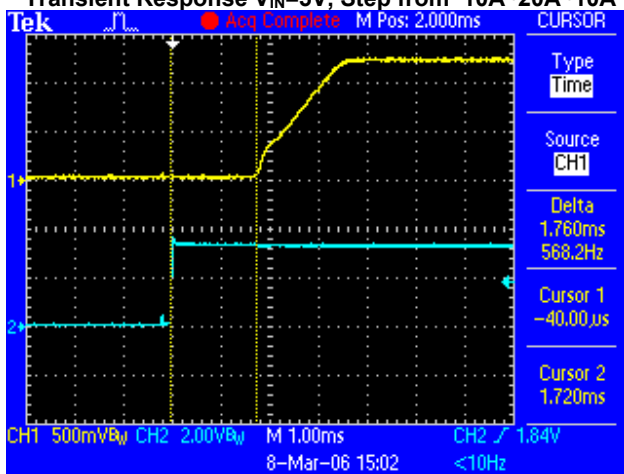

Start-up $V_{IN}=3.3V$, $I_O=18.9A$ (resistive load)

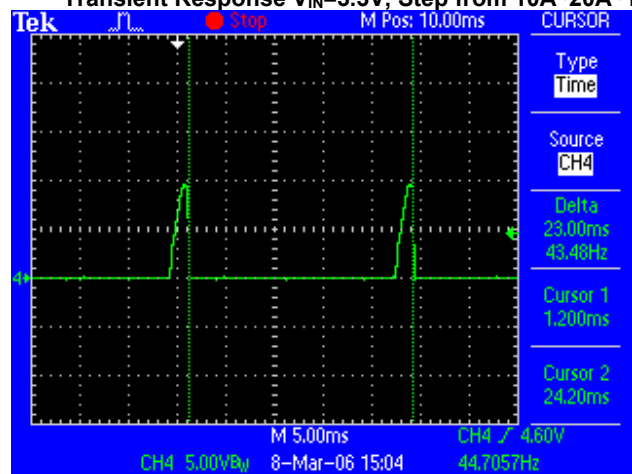

Short-Circuit Output $V_{IN}=3.3V$ (CH4: 30A/Div)

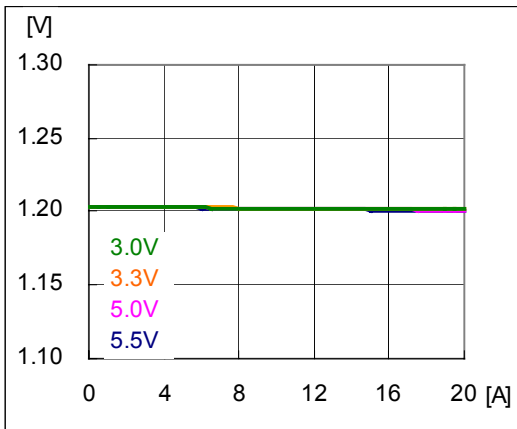

Regulation
Output voltage vs. Load Current,

Output Current Derating (Load Current vs. Ambient Temperature (T_{REF} , See Page 6)), $V_{IN}=5V$,

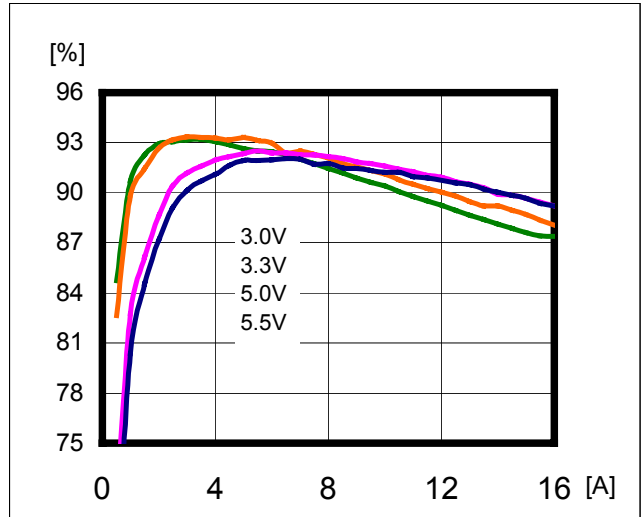

Efficiency

Output Current Derating (Load Current vs. Ambient Temperature (T_{REF} , See Page 6)), $V_{IN}=3.3V$

Typical Characteristics – output adjusted to 1.5V

General conditions:

Input filter 22µF Ceramic + 100µF TAN (150mΩ ESR), Output filter 22µF Ceramic + 100µF TAN (150mΩ ESR)

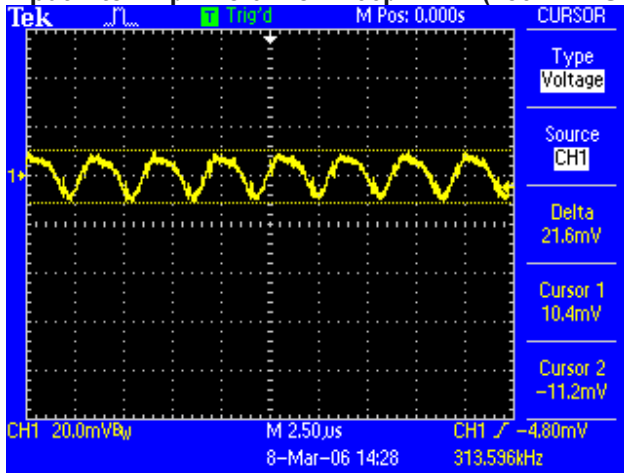

Noise $V_{IN}=5V$, $I_O=20A$, 5~20MHz Bandwidth

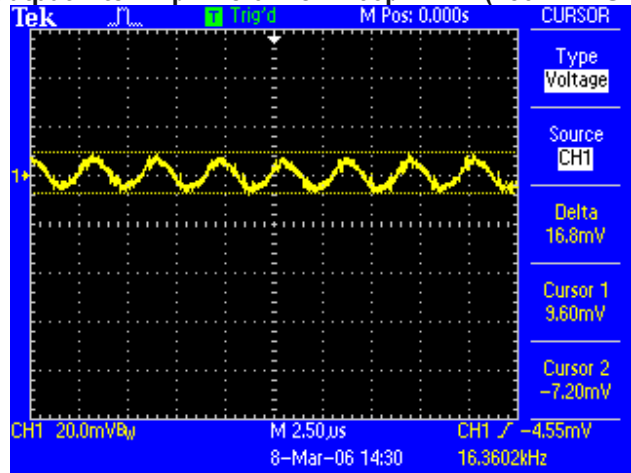

Noise $V_{IN}=3.3V$, $I_O=20A$, 5~20MHz Bandwidth

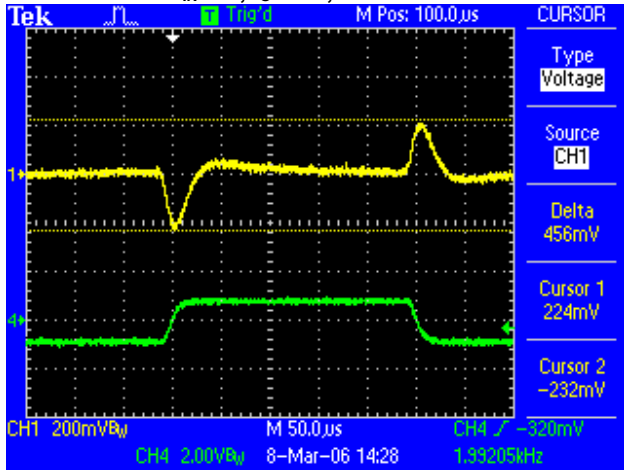

Transient Response $V_{IN}=5V$, Step from 10A~20A~10A

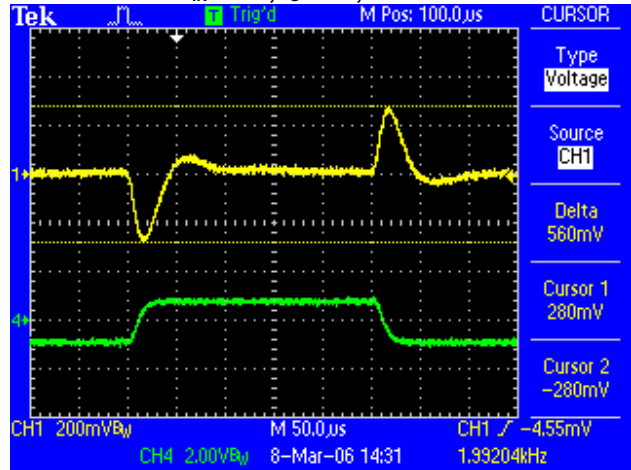

Transient Response $V_{IN}=3.3V$, Step from 10A~20A~10A

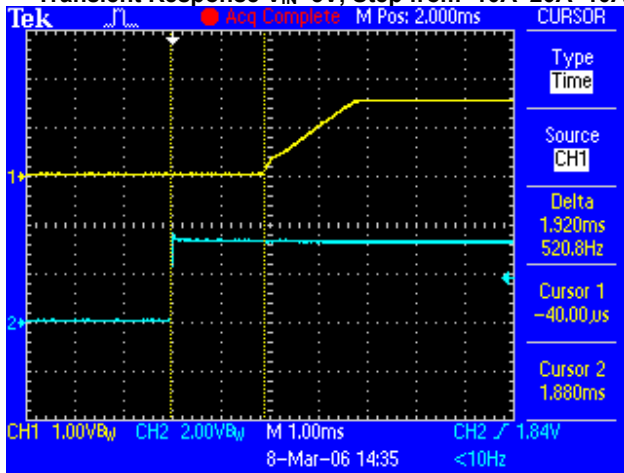

Start-up $V_{IN}=3.3V$, $I_O=20A$ (resistive load)

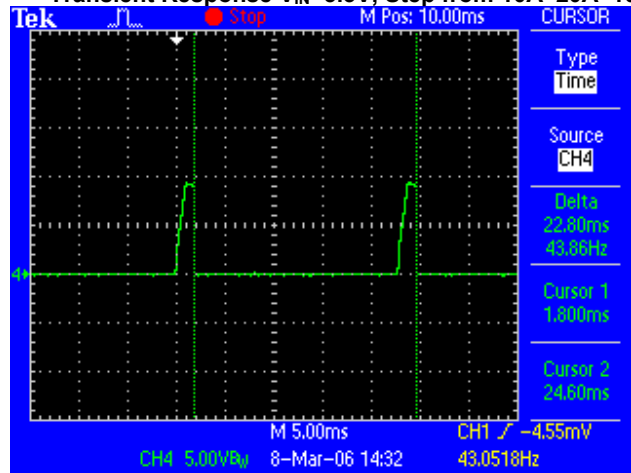

Short-Circuit Output $V_{IN}=3.3V$ (CH4: 30A/Div)

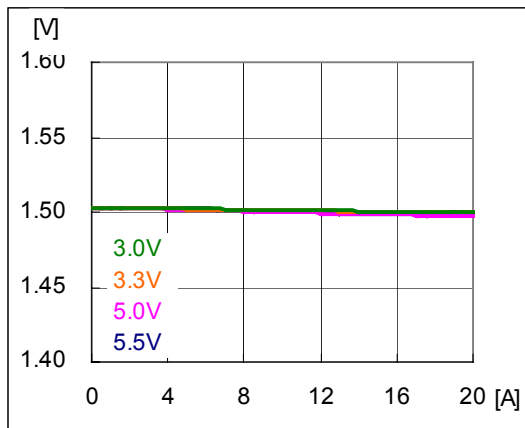

Regulation
Output voltage vs. Load Current,

Output Current Derating (Load Current vs. Ambient Temperature (T_{REF} , See Page 6)), $V_{IN}=5V$,

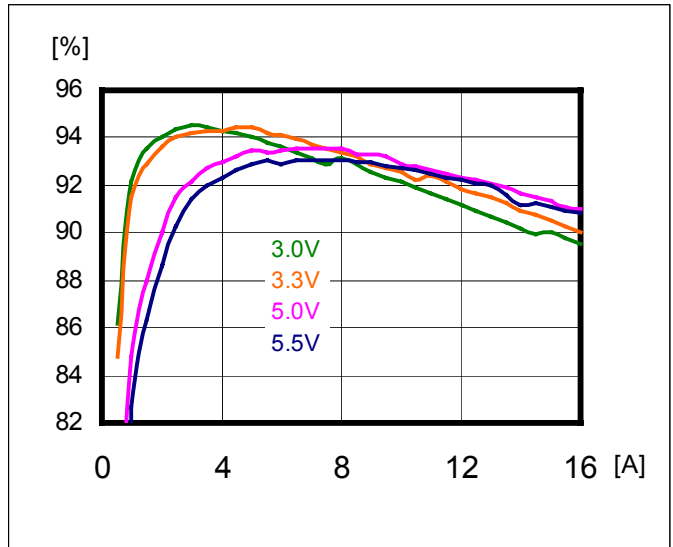

Efficiency

Output Current Derating (Load Current vs. Ambient Temperature (T_{REF} , See Page 6)), $V_{IN}=3.3V$

Typical Characteristics – output adjusted to 1.8V

General conditions:

Input filter 22µF Ceramic + 100µF TAN (150mΩ ESR), Output filter 22µF Ceramic + 100µF TAN (150mΩ ESR)

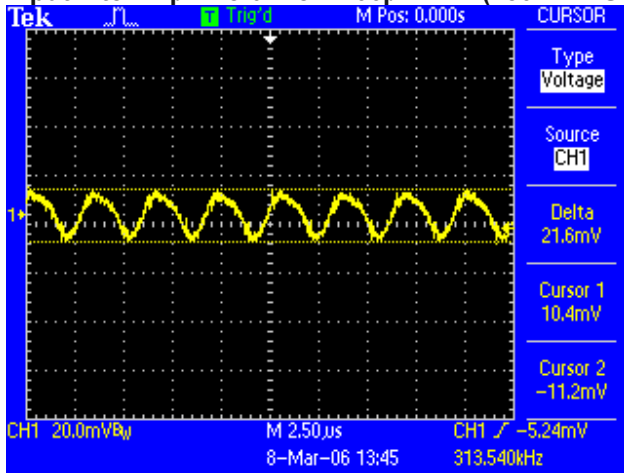

Noise $V_{IN}=5V$, $I_O=20A$, 5~20MHz Bandwidth

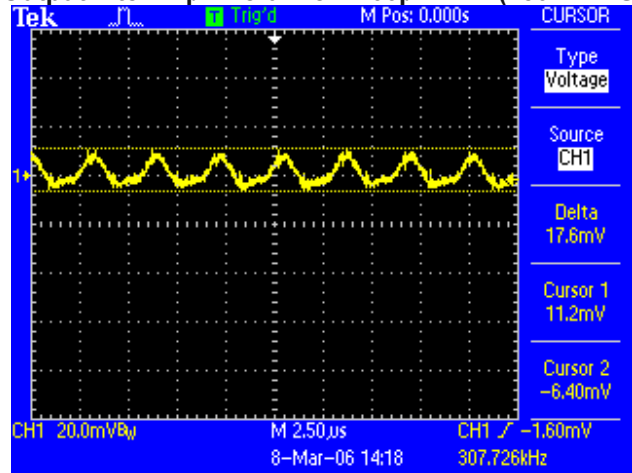

Noise $V_{IN}=3.3V$, $I_O=20A$, 5~20MHz Bandwidth

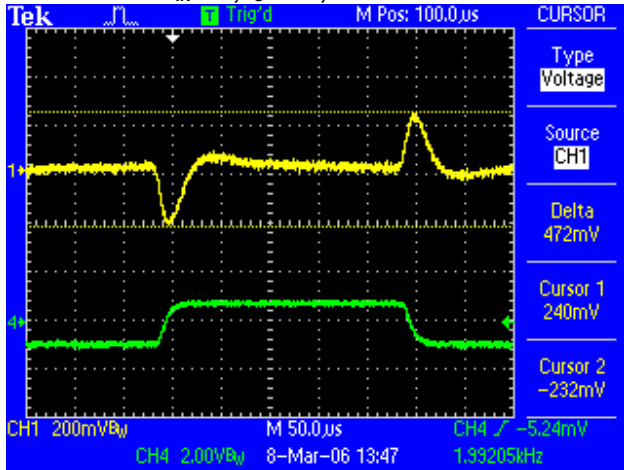

Transient Response $V_{IN}=5V$, Step from 10A~20A~10A

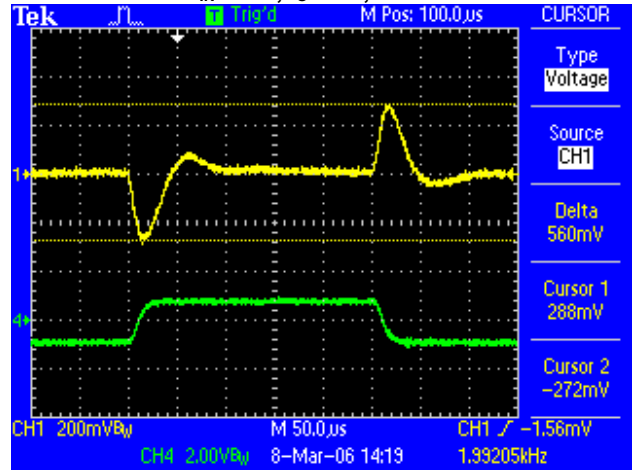

Transient Response $V_{IN}=3.3V$, Step from 10A~20A~10A

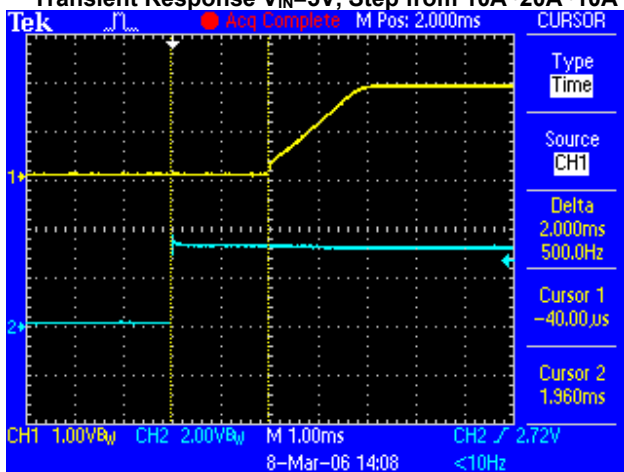

Start-up $V_{IN}=3.3V$, $I_O=20A$ (resistive load)

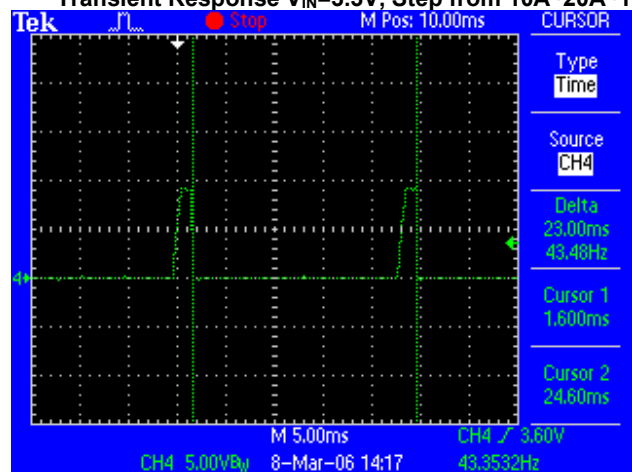

Short-Circuit Output $V_{IN}=3.3V$ (CH4: 30A/Div)

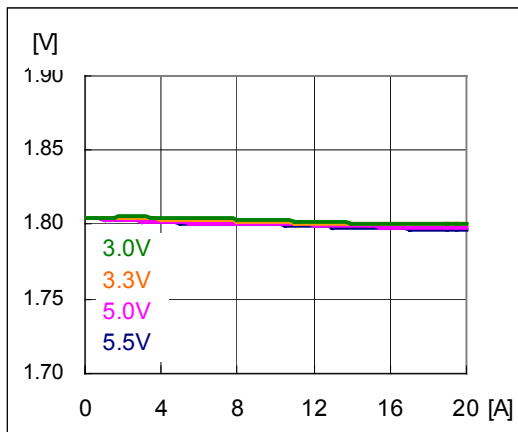

Regulation
Output voltage vs. Load Current,

Output Current Derating (Load Current vs. Ambient Temperature (T_{REF} , See Page 6)), $V_{IN}=5V$,

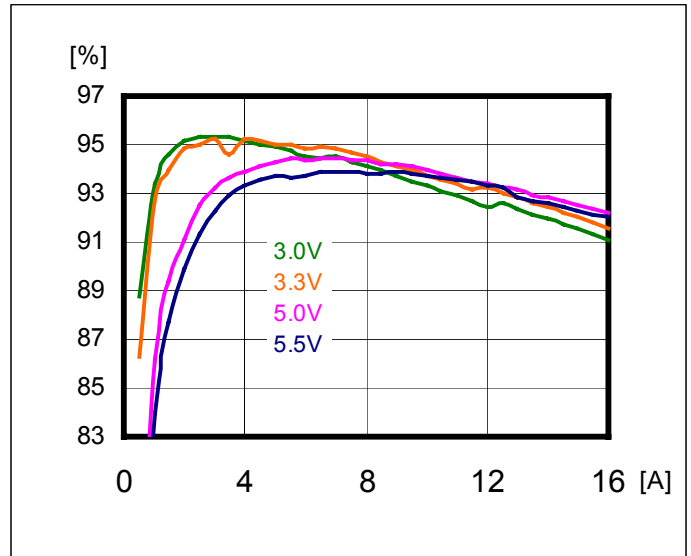

Efficiency

Output Current Derating (Load Current vs. Ambient Temperature (T_{REF} , See Page 6)), $V_{IN}=3.3V$

Typical Characteristics – output adjusted to 2.5V

General conditions:

Input filter 22µF Ceramic + 100µF TAN (150mΩ ESR), Output filter 22µF Ceramic + 100µF TAN (150mΩ ESR)

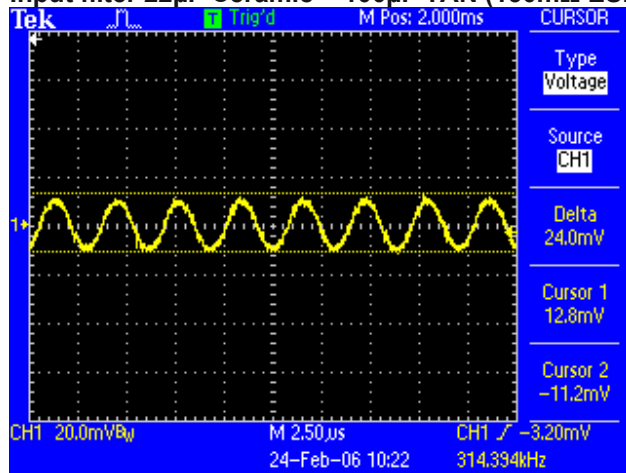

Noise $V_{IN}=5V$, $I_O=20A$, 5~20MHz Bandwidth

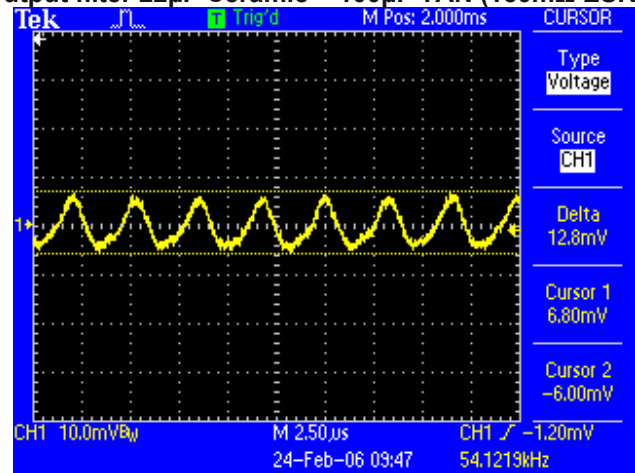

Noise $V_{IN}=3.3V$, $I_O=20A$, 5~20MHz Bandwidth

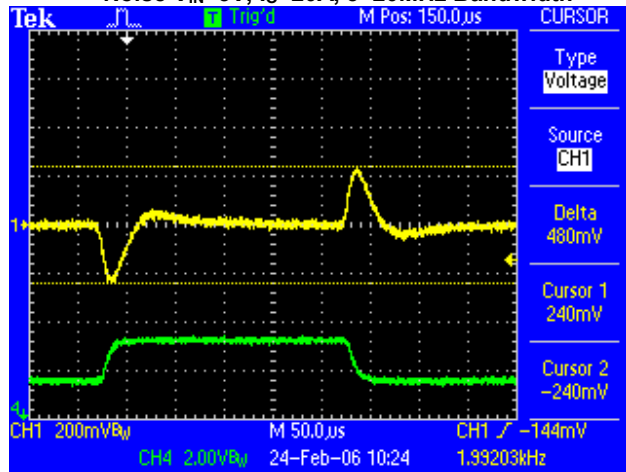

Transient Response $V_{IN}=5V$, Step from 10A~20A~10A

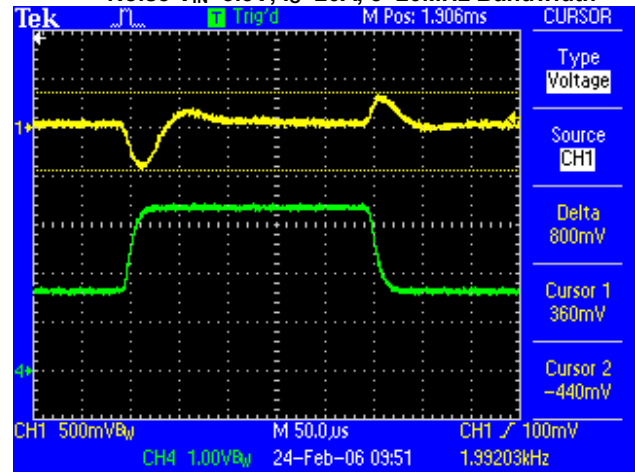

Transient Response $V_{IN}=3.3V$, Step from 10A~20A~10A

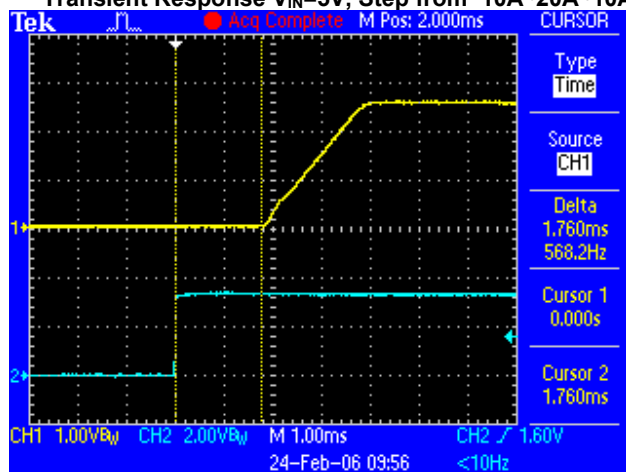

Start-up $V_{IN}=3.3V$, $I_O=20A$ (resistive load)

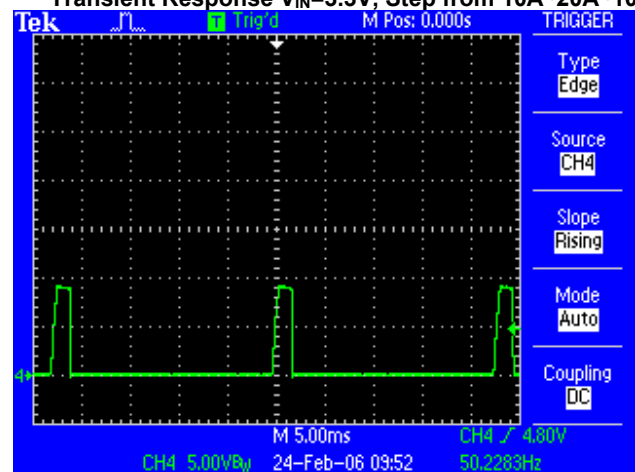

Short-Circuit Output $V_{IN}=3.3V$ (CH4: 30A/Div)

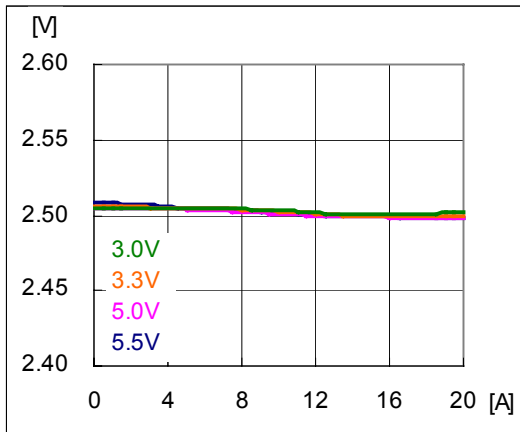

Regulation
Output voltage vs. Load Current,

Output Current Derating (Load Current vs. Ambient Temperature (T_{REF} , See Page 6)), $V_{IN}=5V$,

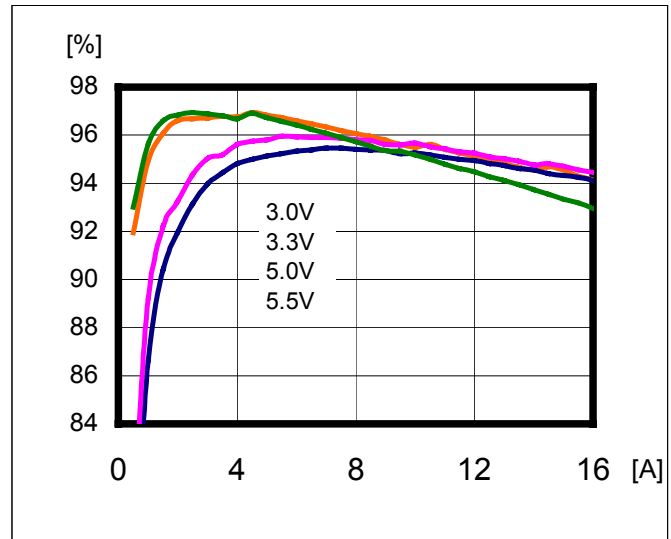

Efficiency

Output Current Derating (Load Current vs. Ambient Temperature (T_{REF} , See Page 6)), $V_{IN}=3.3V$

SuperTarzan™ MQ7260ASMT

Typical Characteristics – output adjusted to 3.3V

General conditions:

Input filter 22µF Ceramic + 100µF TAN (150mΩ ESR), Output filter 22µF Ceramic + 100µF TAN (150mΩ ESR)

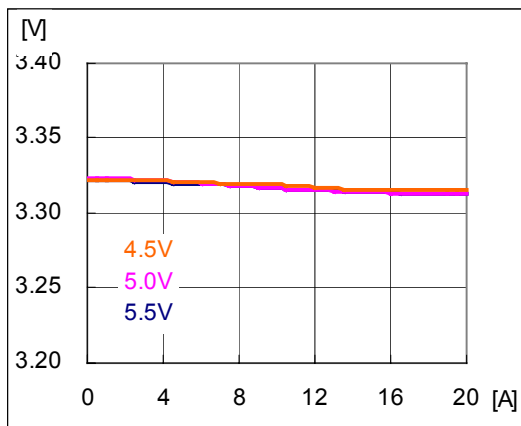
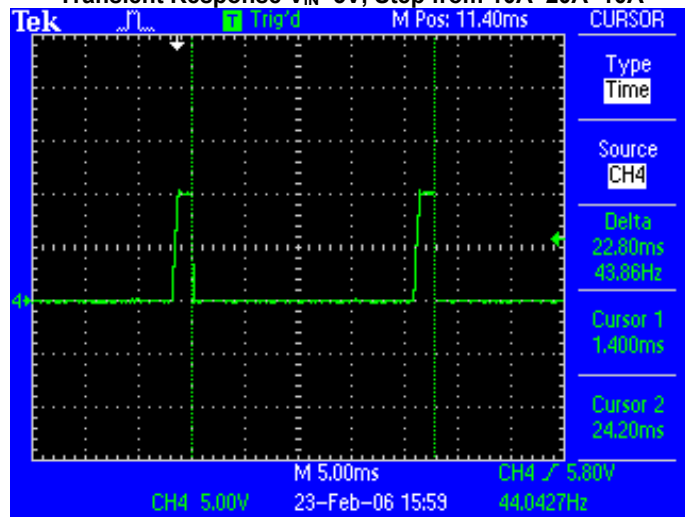
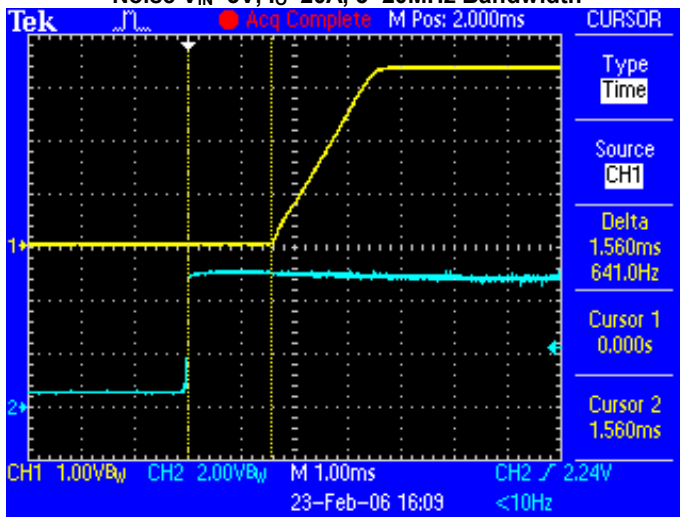
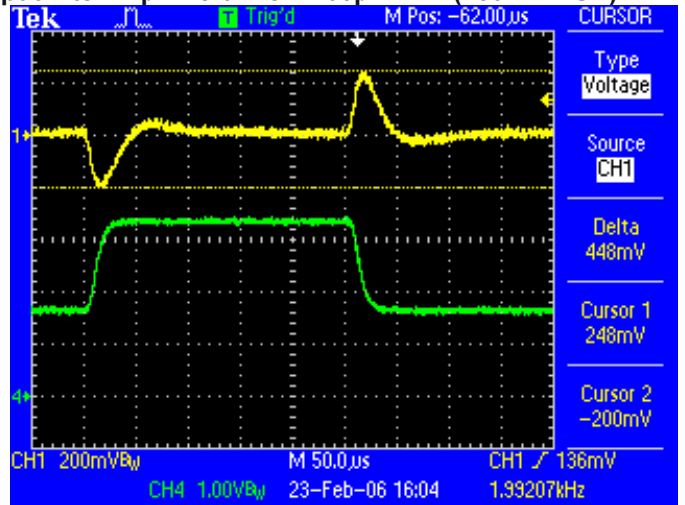
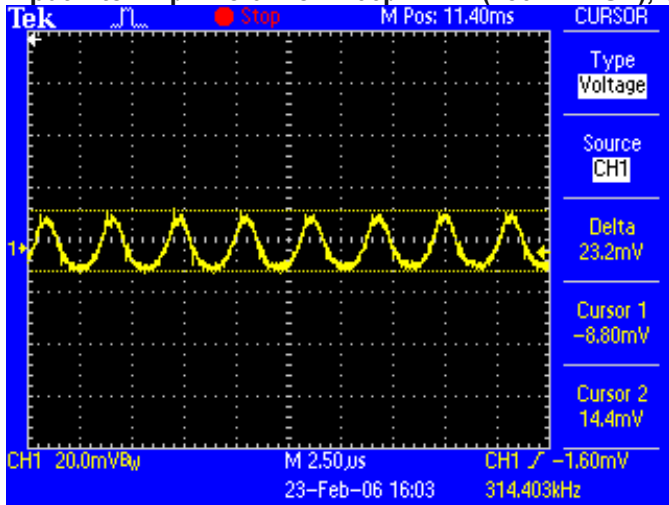

Regulation
Output voltage vs. Load Current,

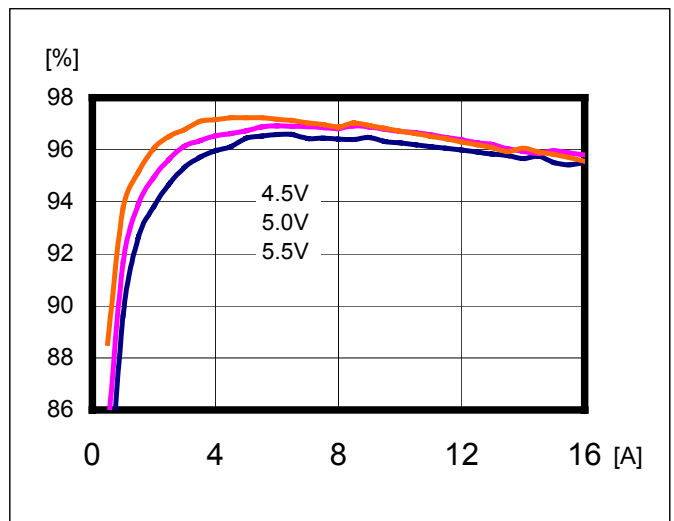

Efficiency

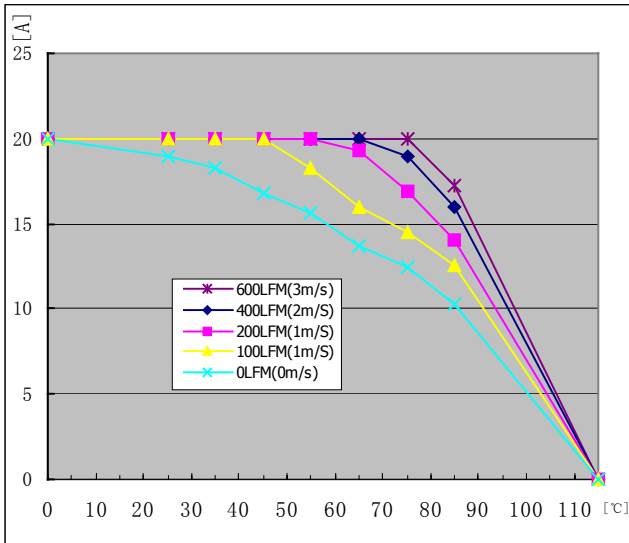

Output Current Derating (Load Current vs. Ambient Temperature (T_{REF} , See Page 6)), $V_{IN}=5V$

Recommended Hole Pattern

Dimensions are in millimeters (inches)

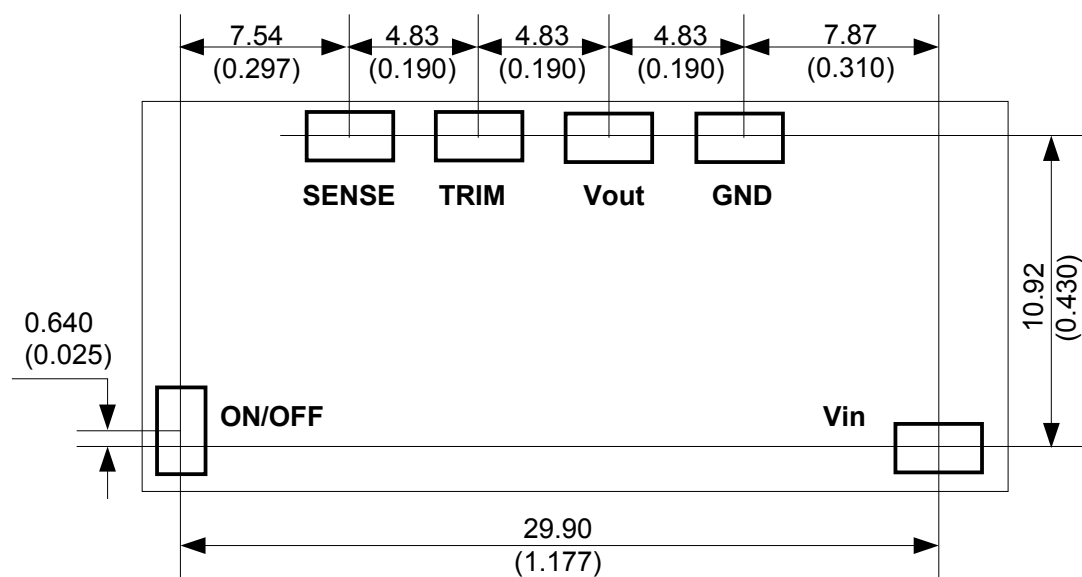

COMPONENT-SIDE FOOTPRINT

PAD SIZE

MIN: 3.556 X 2.413 (0.140 X 0.095)

MAX: 4.19 X 2.79 (0.165 X 0.110)

Application Notes