

MicroTarzan™ MQ7230SMT/IBA
Non-isolated 8~14VDC input, 0.75~5.5V output, 6A DC-DC Converter



Features

- Wide operating voltage: 8V ~ 14V
- Output Current up to 6A
- Output voltage ripple: 20mV_{PP}
- High Efficiency 93%
- Overcurrent /shortcircuit protection
- Over-temperature protection
- Remote on/off control—negative or positive logic
- High reliability: designed to meet 5 million hour MTBF
- Minimal space on PCB:
 - 20.32 mm x 6.7 mm x 11.43 mm or
 - 0.8 in x 0.265 in x 0.45in
- No derating to +75°C, natural convection
- UL/IEC/EN60950 compliant
- RoHS Compliant available

Applications

- Workstations, servers
- Desktop computers
- DSP applications
- Distributed power architectures
- Telecommunications equipment
- Data communications equipment
- Wireless communications equipment

Description

The *MicroTarzan™* MQ7230SMT/IBA Series Power Modules are non-isolated dc-dc converters that operate over a wide input voltage range of 8Vdc to 14Vdc and provide a precisely (2%) regulated dc output with industry standard SMT pin out. Such a module is suitable to application with 10V or 14V power supply bus. The modules have a maximum output current rating of 6A at a typical full-load efficiency over 93%. Standard features include remote on/off with negative or positive logic and output voltage trimmable, over-current protection, over-temperature protection.

MQ7230 can load 6A in a very small size. This improves PCB layout and system integration capability.

***** **Typical Application Circuit** *****

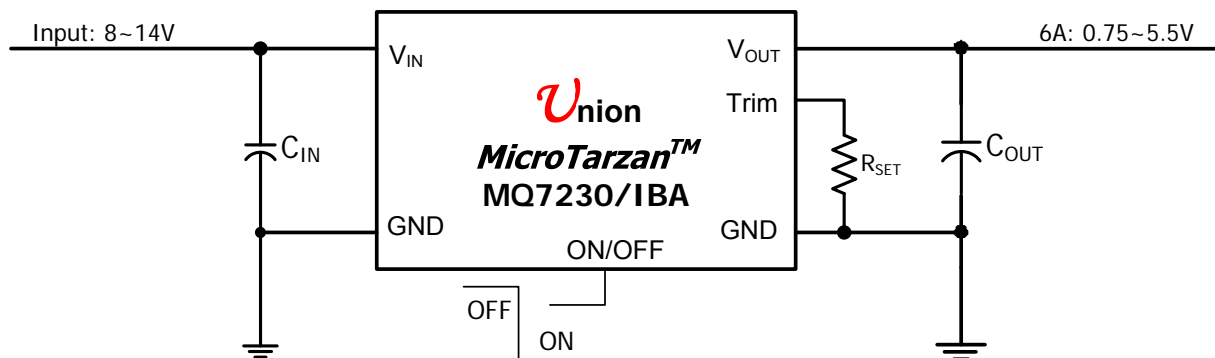

Performance Specifications (at TA=+25°C)

Model	Input V _{IN} Range (V)	Output				Efficiency (%)
		I _{OUT} (A)	Trim Range (V)	Regulation		
				Line (%)	Load (%)	
MQ7230SMT/IBA	8~14	5	0.75V~5.5V	0.5	0.5	93

Mechanical Specifications

Dimensions are in inches (mm)

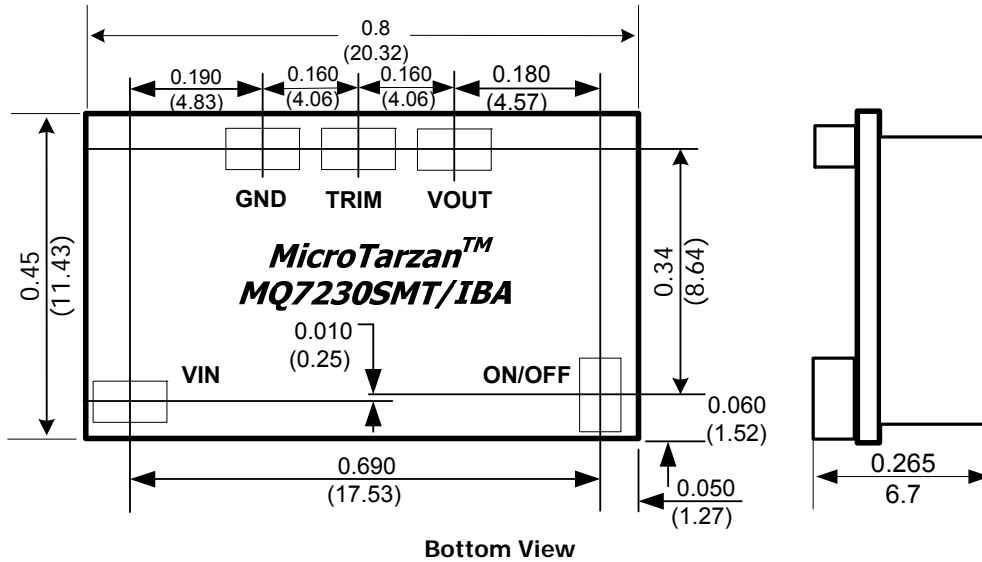

Ordering Information

MQ7230SMT2abcdPG

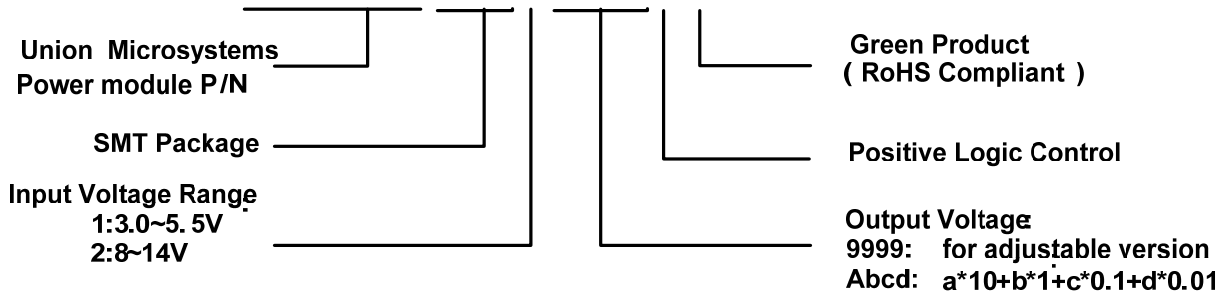

For examples:

MQ7230SMT29999PG means MQ7230 in SMT Pin-out, input voltage 8~14V, output voltage 0.75~5.5V, positive logic control and green product.

MQ7230SMT20150G means MQ7230 in SMT Pin-out, input voltage 8~14V, output voltage 1.5V, negative logic control and green product.

Absolute Maximum Ratings

Note: These are stress ratings. Exposure of devices to any of these conditions may adversely affect long-term reliability. Proper operation under conditions other than those listed in the Performance Specifications Table is not implied.

Parameter	Symbol	Min	Max	Unit
Input Voltage	V _{IN}	-0.3	16	V
Storage Temperature	T _{STG}	-40	125	°C

MQ7230SMT/IBA Electrical Specifications: (T_A=+25°C, input voltage 12V, unless otherwise noted)

Parameter	Condition	Symbol	Min	Typ	Max	Unit
Input Voltage Range		V _{IN}	10		14	V
Output Current		I _o	0		6	A
Output Voltage Set point	100% load	Δ V _o	-2		+2	%
Temperature Regulation	T _A = T _{A.MIN} To T _{A.MAX}	-		0.4		%V _{O.SET}
Output Trim Range	See Performance Specifications (from page 8~20)					
Line Regulation						
Load Regulation						
Output Ripple and Noise Voltage	I_o=5A, 0~20MHz (Detail Please see Ripple Figures, Page 8~21)					
Transient Response						

General Specifications

Parameter	Condition	Symbol	Min	Typ	Max	Unit
Maximum Capacitive Load	5 resistive load + Aluminum capacitor			6600		μF
	5A resistive load +Sanyo POSCAP			2000		
Overcurrent Protection			6.5		10	A
Output short-circuit current (average)	All				2	A
Under Voltage Lockout Trip Level	Rising and falling V _{IN} , 3% hysteresis		7.8	8.0	8.2	V
Positive Logic						
Input High Voltage (Module ON)		V _{IH}			V _{IN.MAX}	V
Input Low Voltage (Module OFF)		V _{IL}	-0.2		0.3	V
Negative Logic						
Input High Voltage (Module OFF)		V _{IH}	2		V _{IN.MAX}	V
Input Low Voltage (Module ON)		V _{IL}	-0.2		0.3	V
Start-up Time	5A resistive load, no external output capacitors			2		mS
Switching Frequency		F _o		300		kHz
Operating Temperature	Natural convection, no forced air flow (with derating of 0.5W/°C when T _A ≥ +55°C)		-40		85	°C
Vibration	3 Axes, 5 Min Each	10~55Hz, 0.35mm, 5g				
	3 Axes, 6 Times Each	Peak Deviation 300g, Settling Time 6mS				
MTBF		5,000,000				Hour

Test Configurations

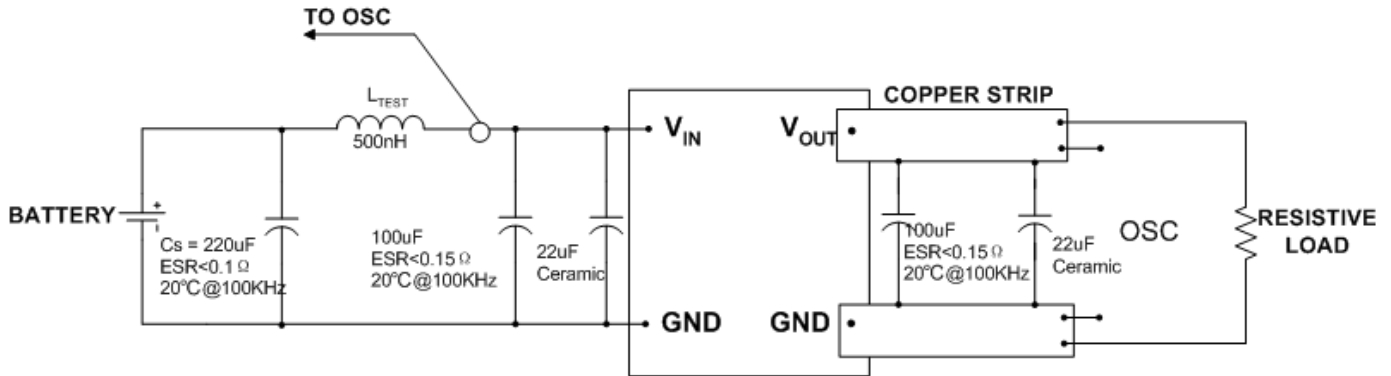

Test setup for input noise, output noise and ripple

Note:

Output noise is measured with 0.1 μ F ceramic capacitor connected at the output. OSC measurement should be made using a BNC socket. Position the load between 50mm and 75mm (2in. and 3in) from the tested module.

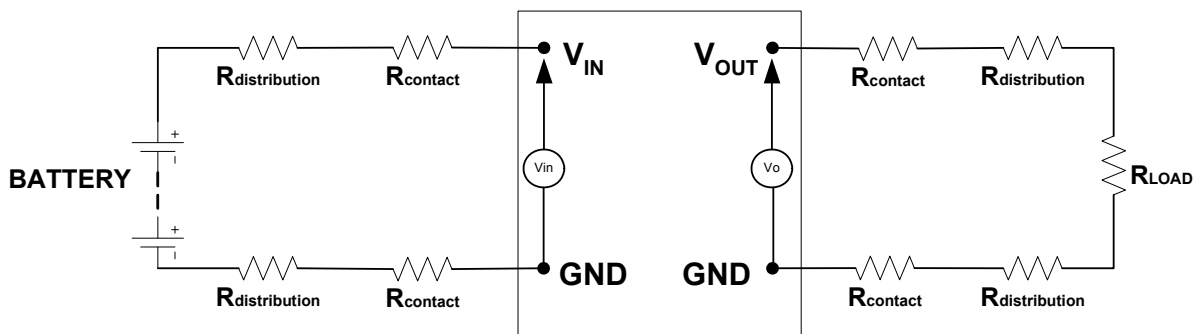

Test setup for efficiency

Note:

All voltage measurements must be taken at the module's terminals, as shown above. If sockets are needed, Kelvin connections are required at the module terminals to avoid measurement errors due to socket contact resistance.

Technical Notes

Input Voltage Range

The MQ7230SMT/IBA Series can be used in a wide variety of applications, esp. most of unregulated 12V intermediate power supply bus system. Its wide input voltage ranges can tolerate worst voltage drop from cheap isolated Brick-type Bus-converter, so it reduces total system cost on power supply.

Return Current Paths

The MQ7230SMT/IBA Series is non-isolated DC/DC converters. To the extent possible with the intent of minimizing ground loops, input and output return current should be directed through pin GND as short as possible.

I/O Filtering

All the specifications of the MQ7230SMT/IBA Series are tested and specified without output capacitors. However, certain input capacitors are necessary to improve the power modules' operating conditions and to reduce the ac impedance. For example, under

some conditions, the power modules can't normally start up when fully loaded due to the high ac-impedance input source. External input capacitors serve primarily as energy-storage devices. They should be added close to the input pins of the MQ7230SMT/IBA and selected for bulk capacitance (at appropriate frequencies), low ESR, and high rms-ripple-current ratings. All external capacitors should have appropriate voltage ratings. To reduce the amount of ripple current fed back to the input supply (input reflected-ripple current), an external L-C filter can be added with the inductance as close to the power module as possible.

MQ7230SMT/IBA's output ripple and transient response can be improved with the increasing output capacitance. When using output capacitors, take care that the total output capacitance does not exceed MQ7230SMT/IBA's Maximum Capacitive Load to avoid the module's protection condition in the start-up.

When an external L-C filter is added to reduce ripple on load, for best results, the filter components should be mounted close to the load circuit rather than the power module.

When testing the relationship between external capacitors and output voltage noise, the oscilloscope's probe should be applied to the module's end directly with scope probe ground less than 10mm in length.

Input Fusing

The MQ7230SMT/IBA Series is not internally fused. Certain applications and/or safety agencies may require the installation of fuses at the inputs of power conversion components. The selection of the fuses should conform to the following:

1. The fuse value should be fast-blow 4.5A fuses.
2. Both input traces must be capable of carrying a current of 1.5 times the value of the fuse without opening.

Safety Considerations

MQ7230SMT/IBA's are non-isolated DC/DC converters. In general, all DC-DC's must be installed in compliance with relevant safety-agency specifications (usually UL/IEC/EN60950). In particular, for a non-isolated converter's output voltage to meet SELV (safety extra low voltage) requirements, its input must be SELV compliant. If the output needs to be ELV (extra low voltage), the input must be ELV.

ON/OFF Control

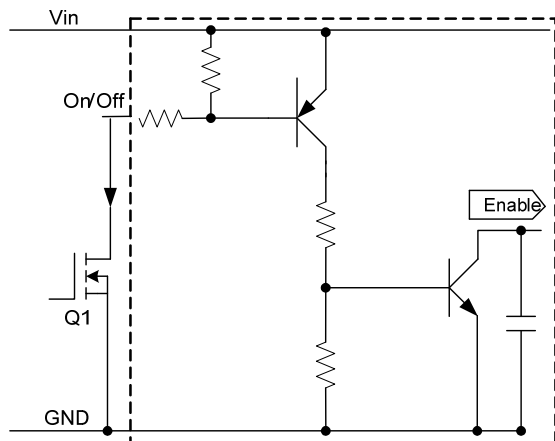

Fig1a. Circuit configuration for using Positive logic On/OFF

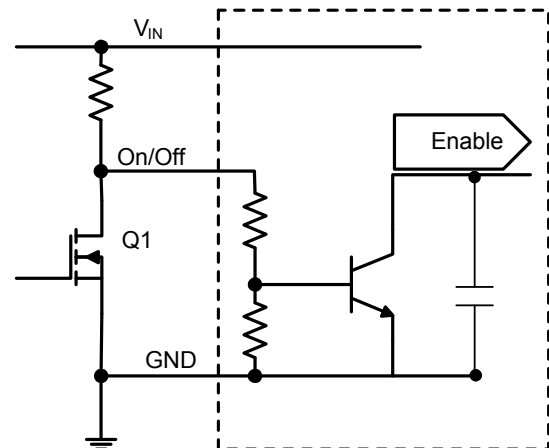

Fig1b. Circuit configuration for using negative logic On/OFF

For positive logic modules, the circuit configuration for using On/Off pin is shown in Fig1a. The On/Off pin is an open collector/drain logic input signal ($V_{on/Off}$) that is referenced to ground. During a logic-high (On/Off pin is pulled high internal to the module) when the Q1 is in the Off state, the power module is ON. Applying a logic-low when the transistor Q1 is turned-On, the power module is Off.

For negative logic On/Off devices, the circuit configuration is shown in Fig1b. The On/Off pin is pulled high with an external pull-up resistor. When transistor Q1 is in Off state, logic High is applied to the On/Off pin and the power is Off. The minimum On/off voltage for logic High on the On/Off pin is 2.5Vdc. To turn the module ON, logic low is applied to the On/Off pin by turning on Q1

The regulator will run in normal operation when the ON/OFF pin is left open.

Output Overvoltage Protection

MQ7230SMT/IBA Series products do not incorporate output overvoltage protection. If the operating circuit requires protection against abnormal output voltage, voltage-limiting circuitry must be provided external to the power module.

Output Overcurrent Protection (OCP)

MQ7230SMT/IBA incorporates overcurrent and short circuit protection. If the load current exceeds the overcurrent protection setpoint, the MQ7230SMT/IBA's internal overcurrent-protection circuitry immediately turns off the module, which then goes into Hiccup mode. The unit operates normally once the output current is brought back into its specified range. The typical average output current during hiccup is less than 2A.

Caution: Be careful never to operate MQ7230SMT/IBA in a "heavy overload" condition that is between the rated output current and the overcurrent protection setpoint. This can cause permanent damage to the components.

Overtemperature Protection (OTP)

To ensure MQ7230SMT/IBA's reliability and avoid damaging its internal components, MQ7230SMT/IBA incorporates overtemperature protection circuit. When the temperature of the PCB is above 130°C, the overtemperature protection circuit will be enabled and the module will stop working. when the temperature of the temperature-testing component is below about 80°C, the overtemperature protection circuit will release and the module will automatically recover from shutdown. To avoid permanently damaging components, the surface temperature of MQ7230SMT/IBA's power components, esp. of the MOSFET should be ensured below 130°C.

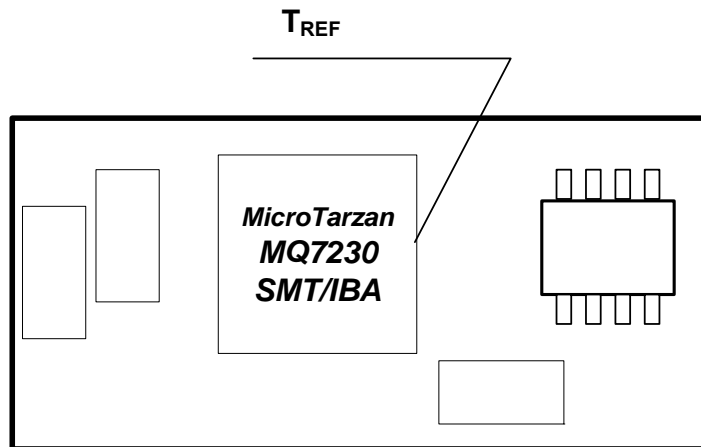

Fig2, Temperature Reference Point

Note: The overtemperature protection may be issued when MQ7230SMT/IBA operates in a "heavy overload" condition for a long time. Thus, the air flow should be improved.

Output Voltage Trimming

MQ7230SMT/IBA's output voltage can be trimmed in certain ranges. Figure 3 shows the circuit used to program output voltage. See Performance Specifications for allowable trim ranges in detail. Also customized products are available.

Trim with external resistor (Fig3), the equation as below:

$$R_{TRIM} = \frac{10500}{V_o - 0.7525} - 1000$$

Resistor values are in Ω; V_o is desired output voltage.

For examples, to trim output to 1.5V, then

$$R_{TRIM} = \frac{10500}{1.5 - 0.7525} - 1000 = 13046$$

So, R_{TRIM} = 13.046kΩ

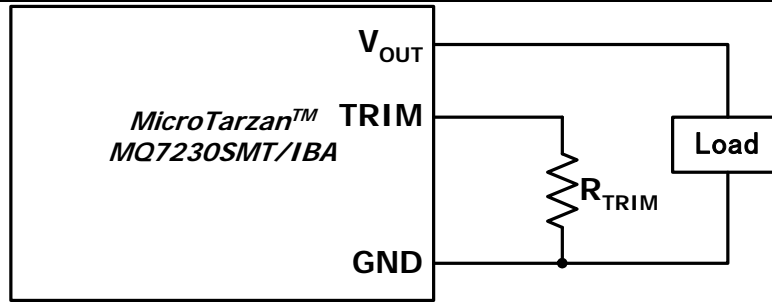

Fig3. Circuit configuration for programming output voltage using external resistor

For most common voltages, the required Trim resistors are as Table 1.

Table 1, the required trim resistors R_{TRIM} for most common voltages

Desired Voltages (V)	R_{TRIM} (k Ω)
0.7525	Open
1.2	22.46
1.5	13.05
1.8	9.024
2.5	5.009
3.3	3.122
5.0	1.472

Typical Characteristics – output adjusted to 1V

General conditions:

Input filter 22µF Ceramic + 47µF TAN (150mΩ ESR), Output filter 22µF Ceramic + 100µF TAN (150mΩ ESR)

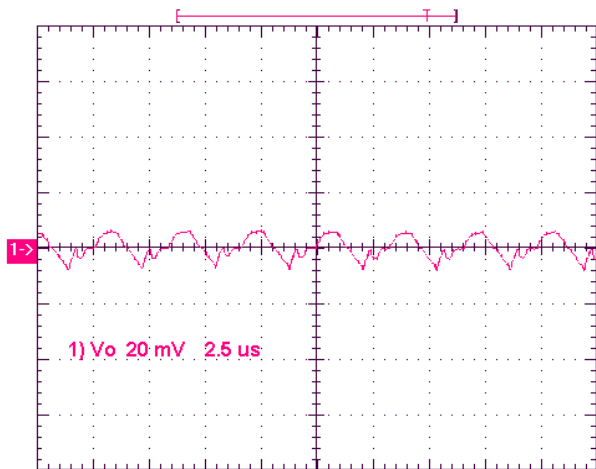

Noise $V_{IN}=12V$, $I_o=5A$, 5~20MHz Bandwidth

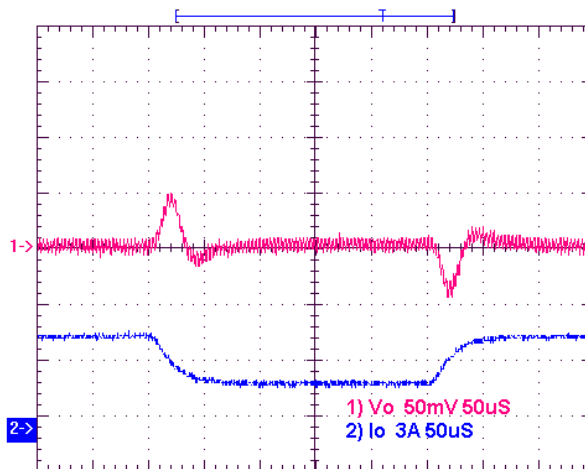

Transient Response $V_{IN}=12V$, Step from 2.5A~5A~2.5A

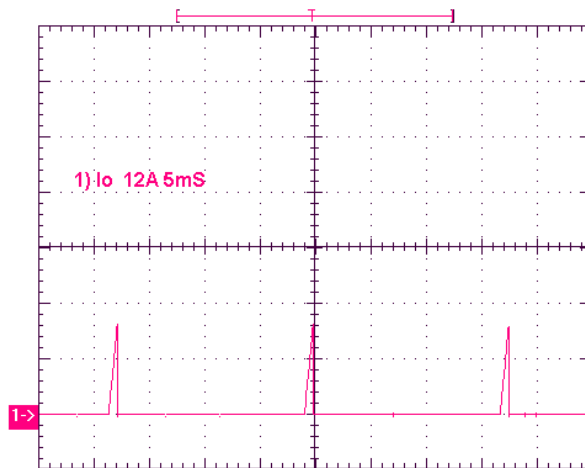

Short-Circuit Output $V_{IN}=12V$

Start-up $V_{IN}=12V$, $I_o=5A$

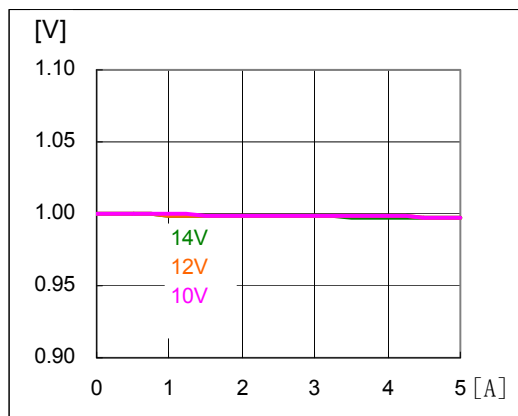

Regulation
Output voltage vs. Load Current

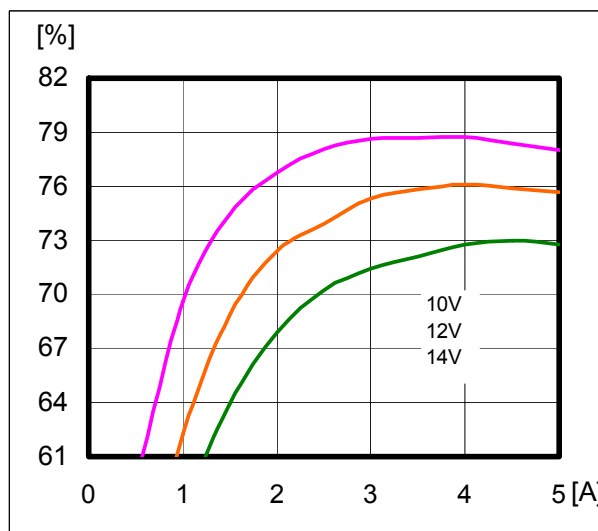

Efficiency

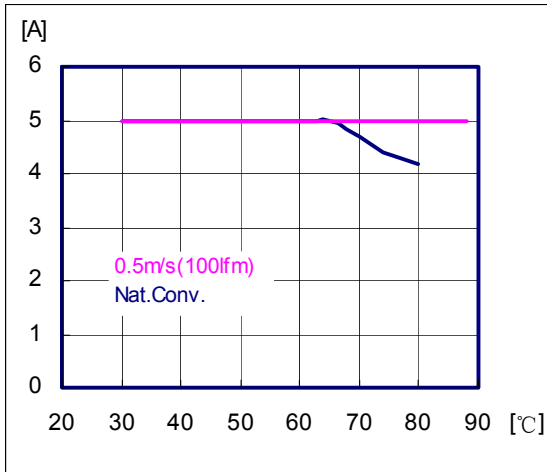

Output Current Derating (Load Current vs. Ambient Temperature (T_{REF} , See Page 6)), $V_{IN}=12V$

Typical Characteristics – output adjusted to 1.2V

General conditions:

Input filter 22µF Ceramic + 47µF TAN (150mΩ ESR), Output filter 22µF Ceramic + 100µF TAN (150mΩ ESR)

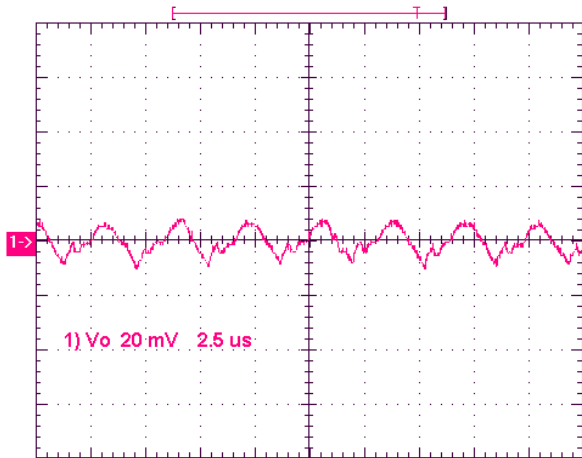

Noise $V_{IN}=12V$, $I_O=5A$, 5~20MHz Bandwidth

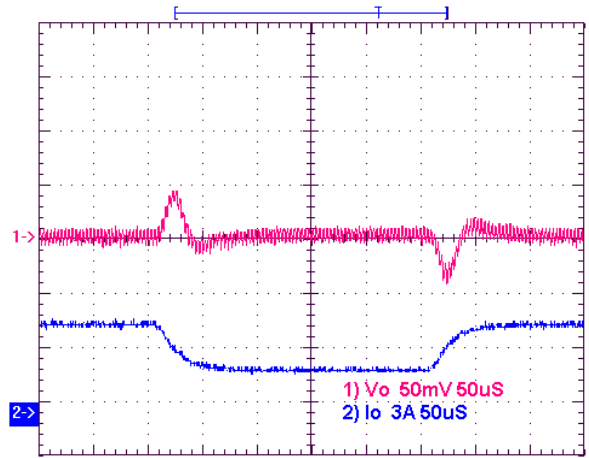

Transient Response $V_{IN}=12V$, Step from 2.5A~5A~2.5A

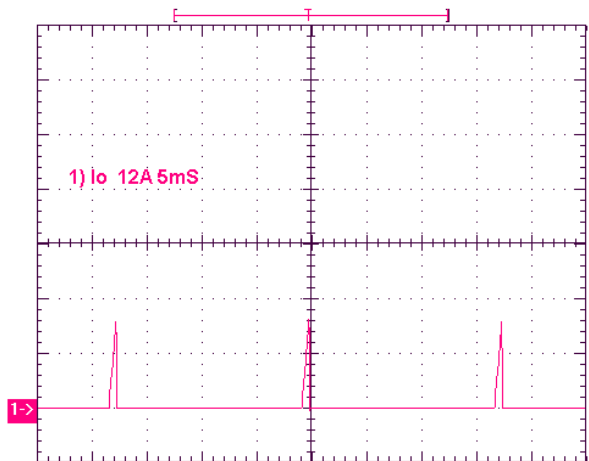

Short-Circuit Output $V_{IN}=12V$

Start-up $V_{IN}=12V$, $I_O=5A$

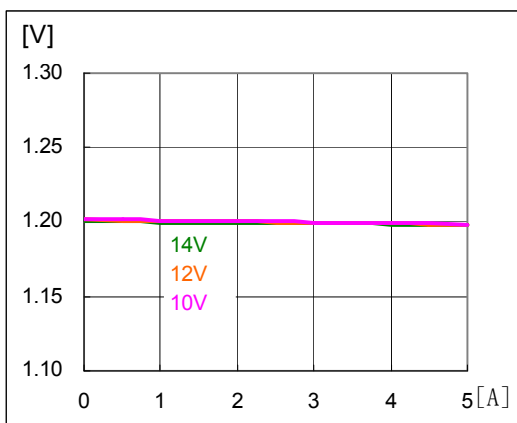

Regulation
Output voltage vs. Load Current

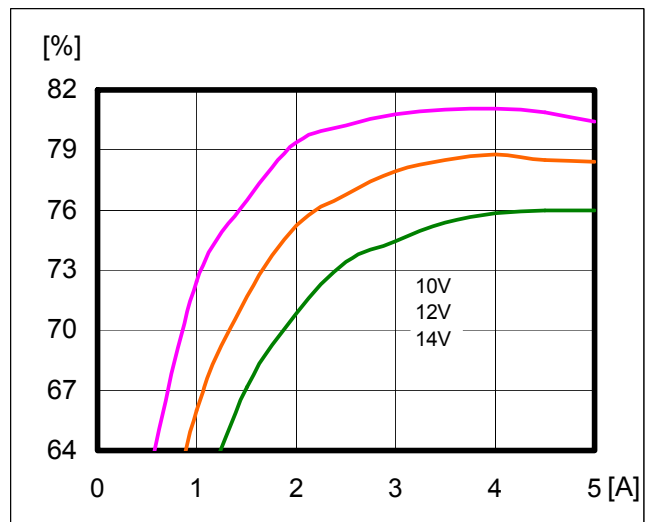

Efficiency

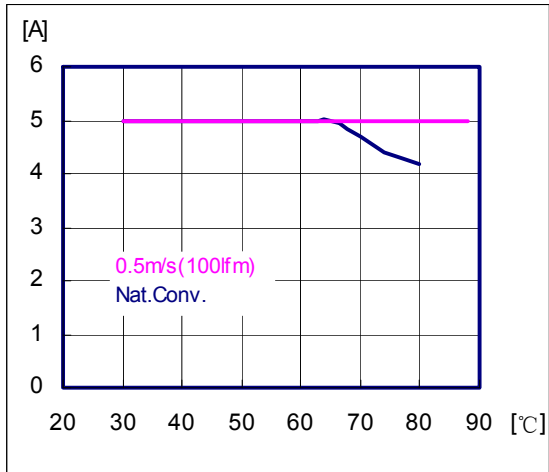

Output Current Derating (Load Current vs. Ambient Temperature (T_{REF} , See Page 6)), $V_{IN}=12V$

Typical Characteristics – output adjusted to 1.5V

General conditions:

Input filter 22µF Ceramic + 47µF TAN (150mΩ ESR), Output filter 22µF Ceramic + 100µF TAN (150mΩ ESR)

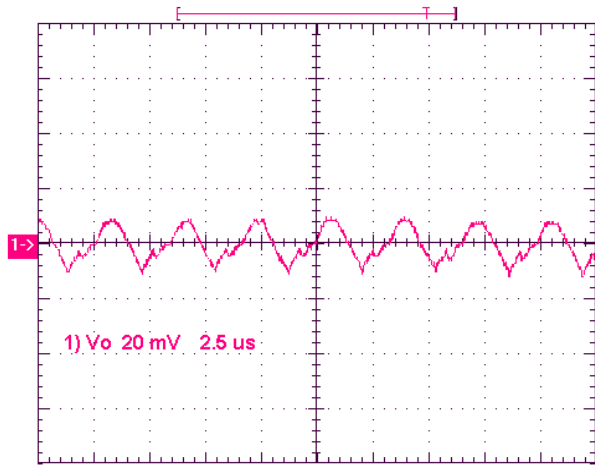

Noise $V_{IN}=12V$, $I_O=5A$, 5~20MHz Bandwidth

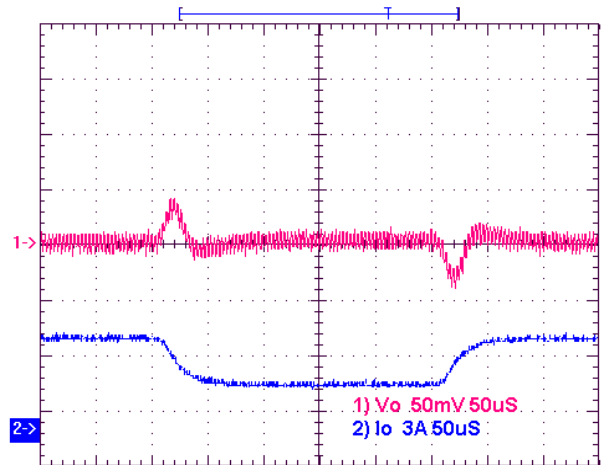

Transient Response $V_{IN}=12V$, Step from 2.5A~5A~2.5A

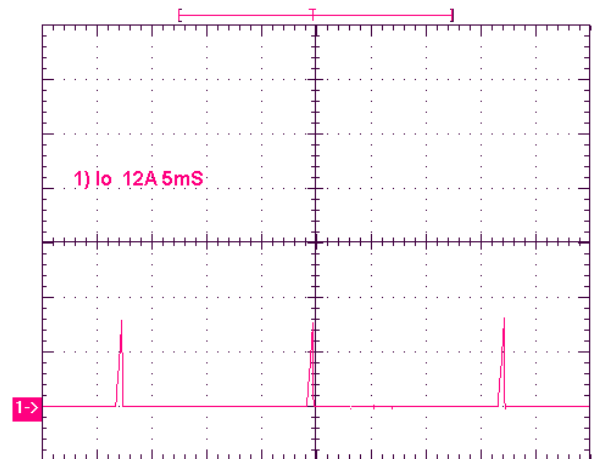

Short-Circuit Output $V_{IN}=12V$

Start-up $V_{IN}=12V$, $I_O=5A$

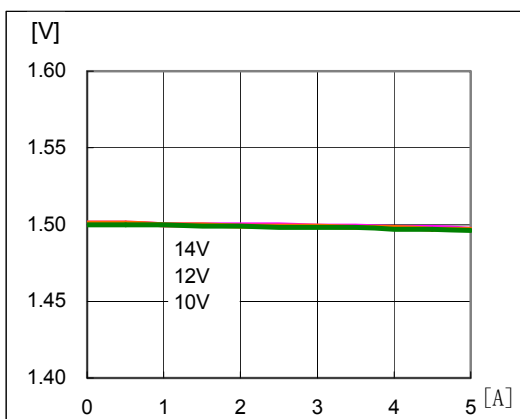

Regulation
Output voltage vs. Load Current

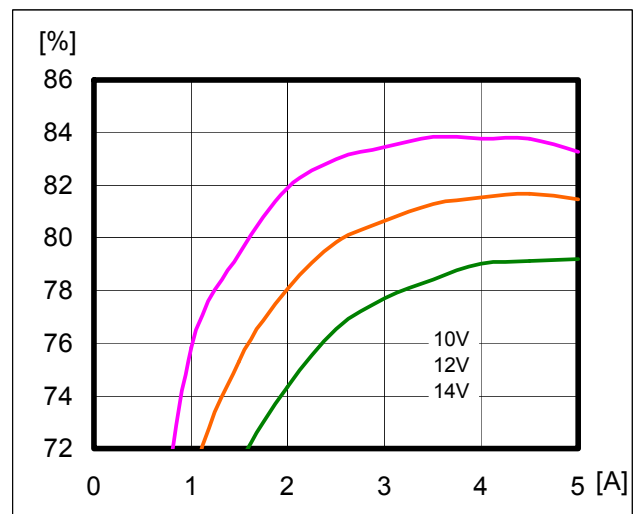

Efficiency

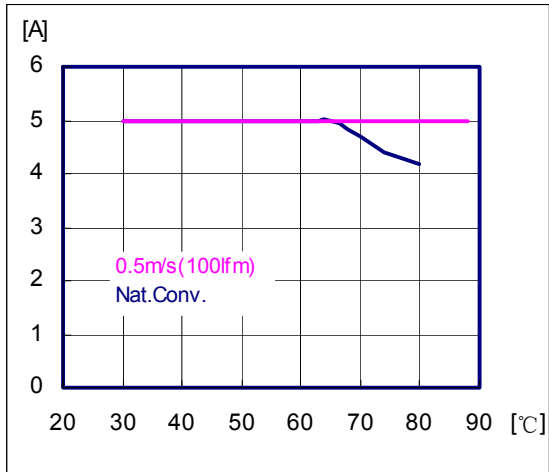

Output Current Derating (Load Current vs. Ambient Temperature (T_{REF} , See Page 6)), $V_{IN}=12V$

Typical Characteristics – output adjusted to 1.8V

General conditions:

Input filter 22µF Ceramic + 47µF TAN (150mΩ ESR), Output filter 22µF Ceramic + 100µF TAN (150mΩ ESR)

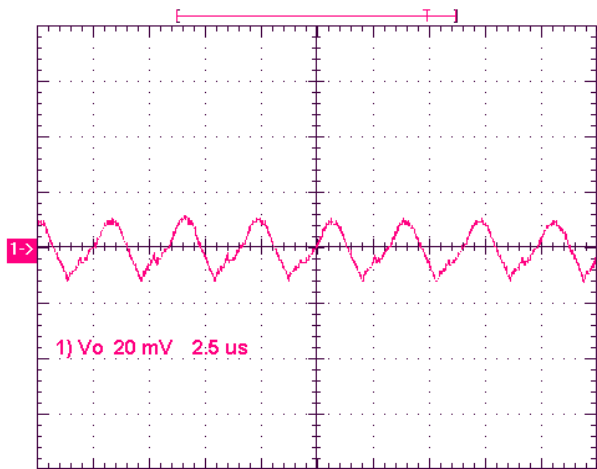

Noise $V_{IN}=12V$, $I_O=5A$, 5~20MHz Bandwidth

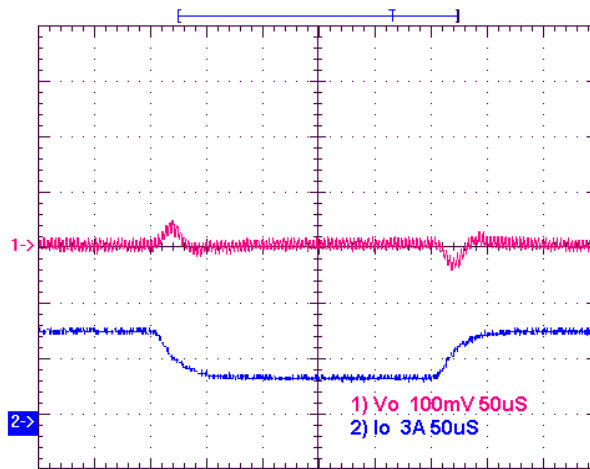

Transient Response $V_{IN}=12V$, Step from 2.5A~5A~2.5A

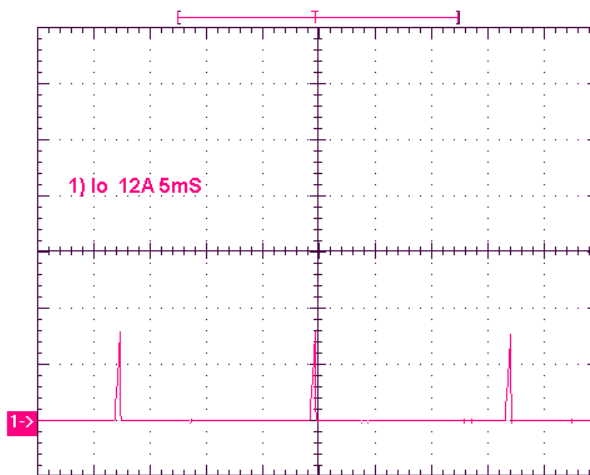

Short-Circuit Output $V_{IN}=12V$

Start-up $V_{IN}=12V$, $I_O=5A$

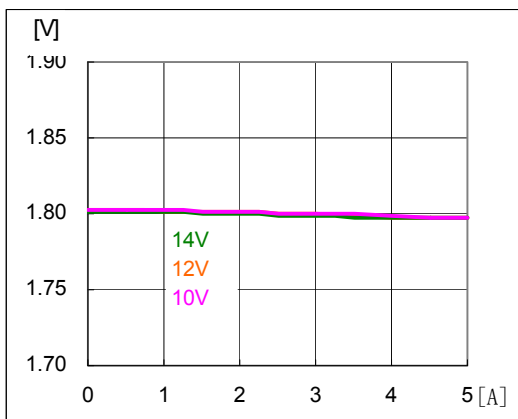

Regulation
Output voltage vs. Load Current

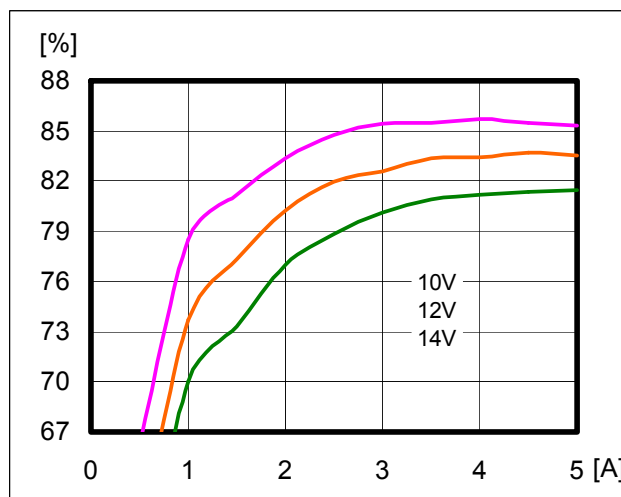

Efficiency

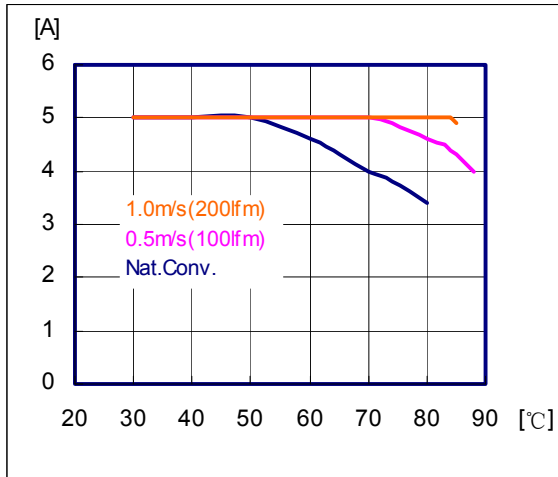

Output Current Derating (Load Current vs. Ambient Temperature (T_{REF} , See Page 6)), $V_{IN}=12V$

Typical Characteristics – output adjusted to 2.5V

General conditions:

Input filter 22µF Ceramic + 47µF TAN (150mΩ ESR), Output filter 22µF Ceramic + 100µF TAN (150mΩ ESR)

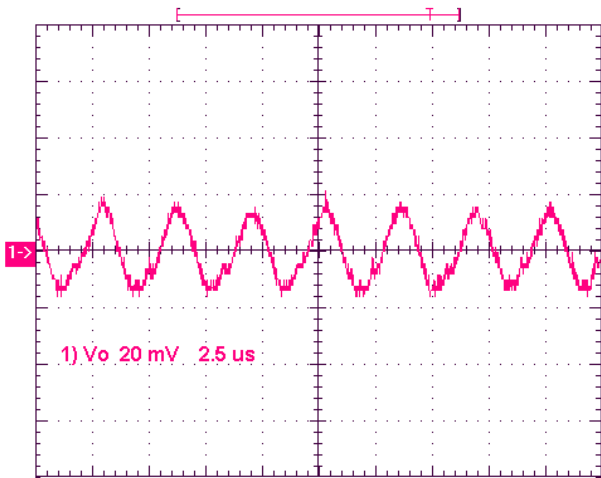

Noise $V_{IN}=12V$, $I_O=5A$, 5~20MHz Bandwidth

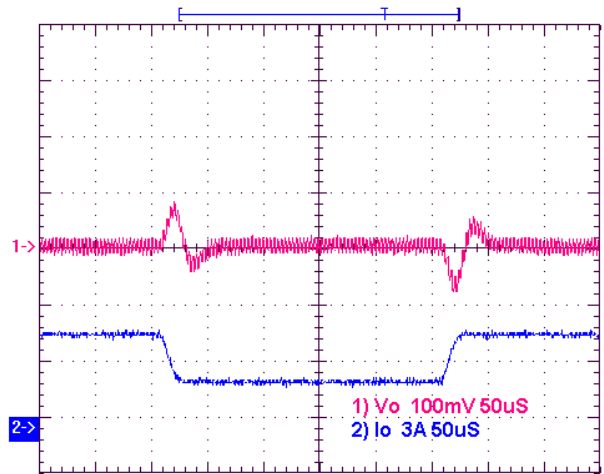

Transient Response $V_{IN}=12V$, Step from 2.5A~5A~2.5A

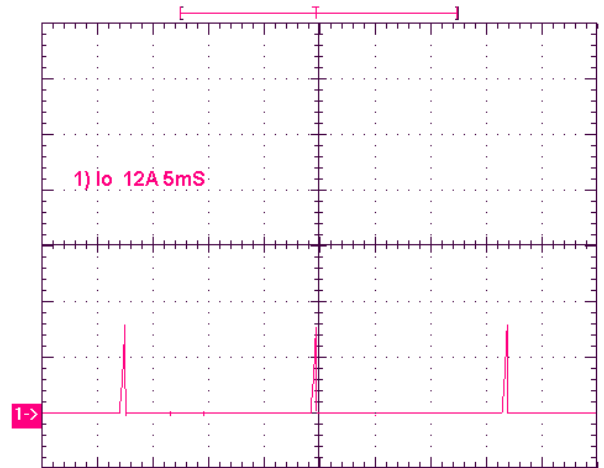

Short-Circuit Output $V_{IN}=12V$

Start-up $V_{IN}=12V$, $I_O=5A$

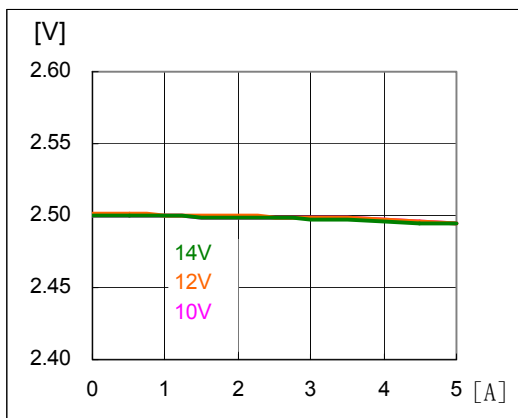

Regulation
Output voltage vs. Load Current

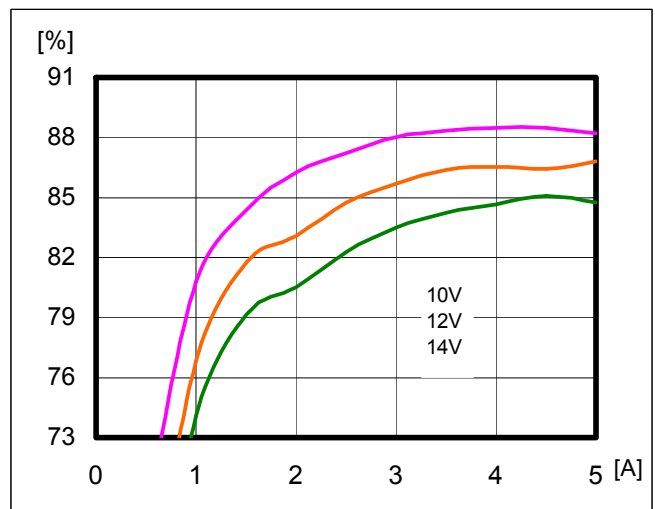

Efficiency

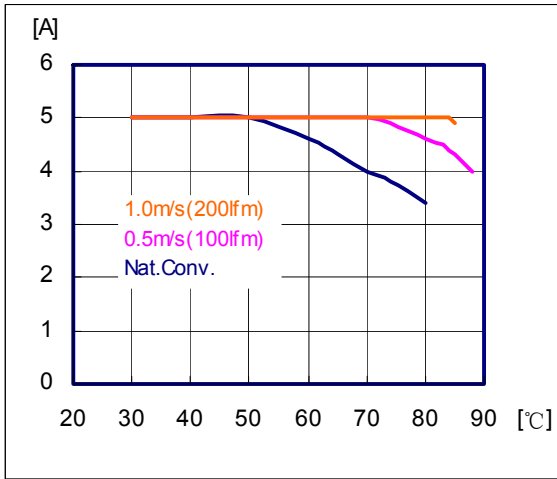

Output Current Derating (Load Current vs. Ambient Temperature (T_{REF} , See Page 6)), $V_{IN}=12V$,

Typical Characteristics – output adjusted to 3.3V

General conditions:

Input filter 22µF Ceramic + 47µF TAN (150mΩ ESR), Output filter 22µF Ceramic + 100µF TAN (150mΩ ESR)

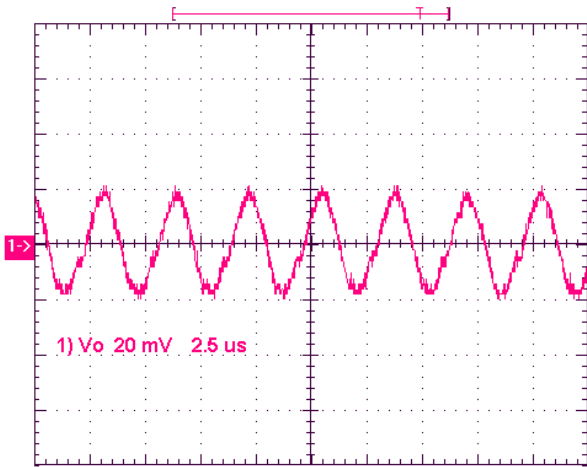

Noise $V_{IN}=12V$, $I_o=5A$, 5~20MHz Bandwidth

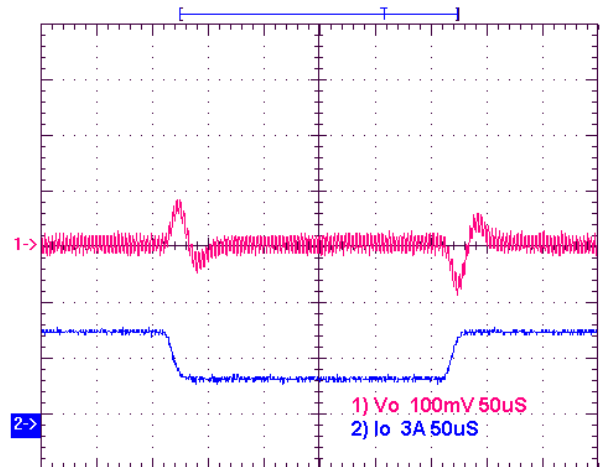

Transient Response $V_{IN}=12V$, Step from 2.5A~5A~2.5A

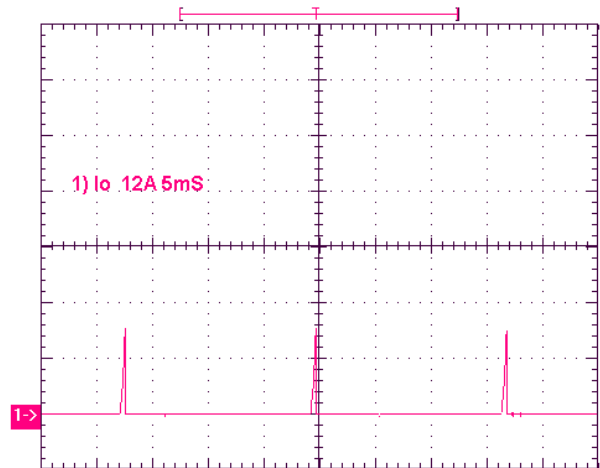

Short-Circuit Output $V_{IN}=12V$

Start-up $V_{IN}=12V$, $I_o=5A$

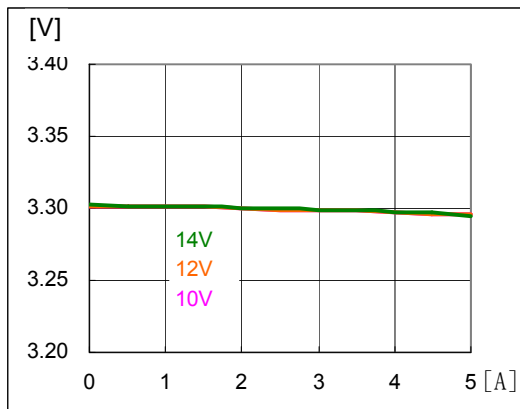

Regulation
Output voltage vs. Load Current

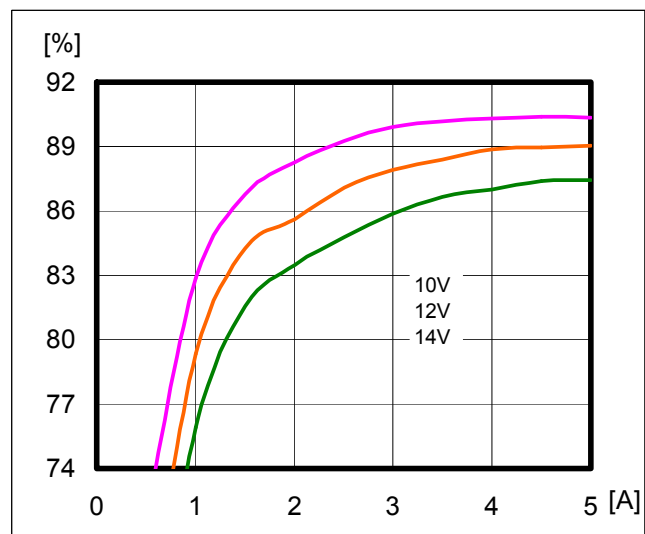

Efficiency

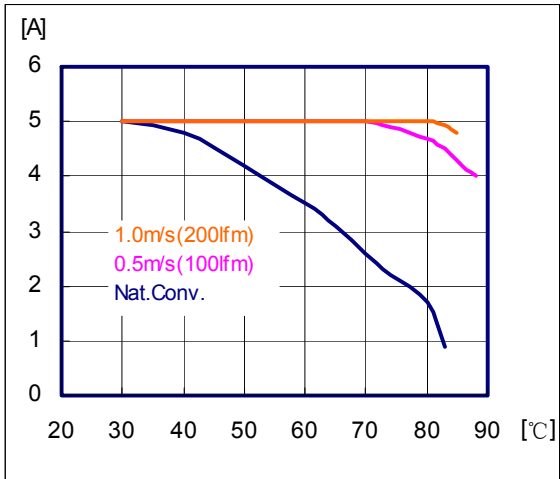

Output Current Derating (Load Current vs. Ambient Temperature (T_{REF} , See Page 6)), $V_{IN}=12V$,

Typical Characteristics – output adjusted to 5.0V

General conditions:

Input filter 22µF Ceramic + 47µF TAN (150mΩ ESR), Output filter 22µF Ceramic + 100µF TAN (150mΩ ESR)

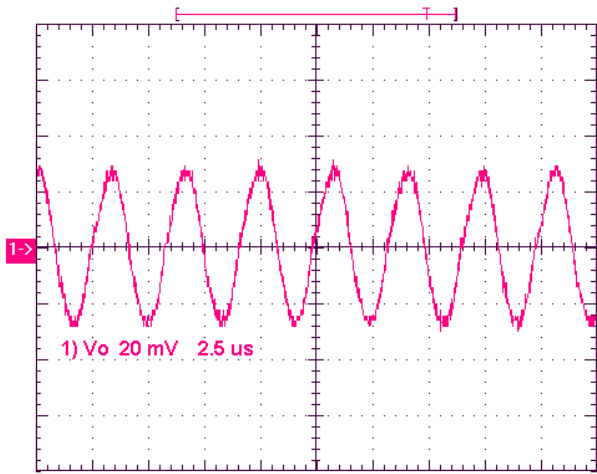

Noise $V_{IN}=12V$, $I_O=5A$, 5~20MHz Bandwidth

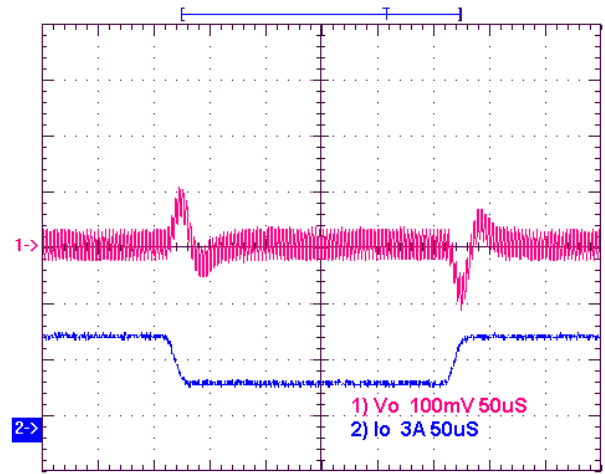

Transient Response $V_{IN}=12V$, Step from 2.5A~5A~2.5A

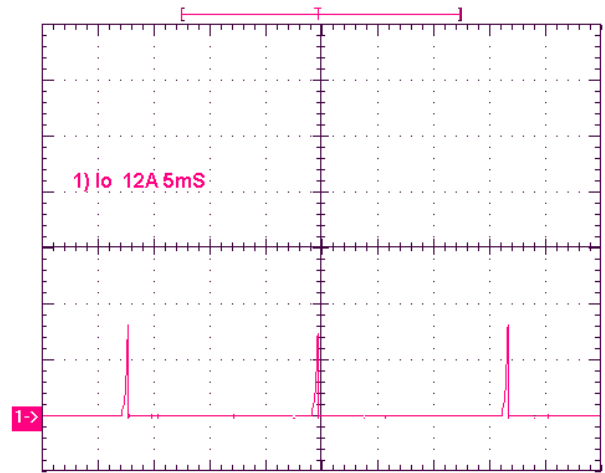

Short-Circuit Output $V_{IN}=12V$

Start-up $V_{IN}=12V$, $I_O=5A$

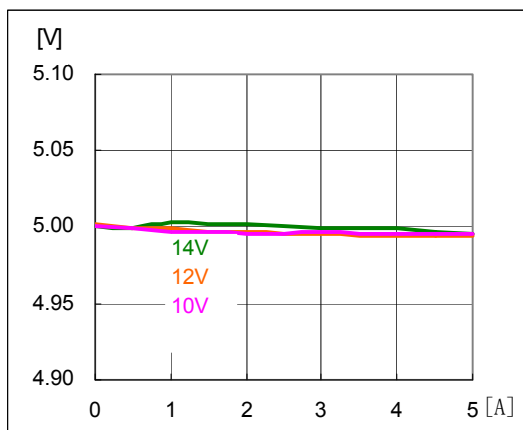

Regulation
Output voltage vs. Load Current

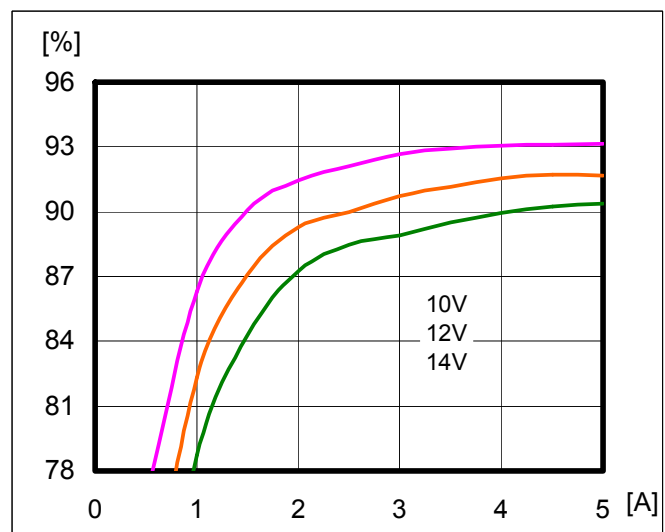

Efficiency

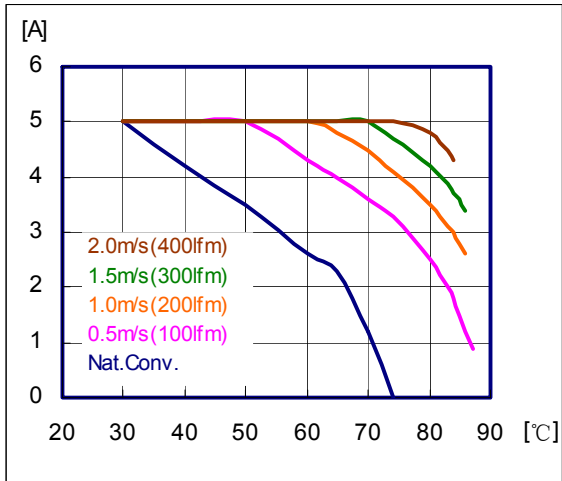

Output Current Derating (Load Current vs. Ambient Temperature (T_{REF} , See Page 6)), $V_{IN}=12V$,

Recommended Hole Pattern

Dimensions are in inches (millimeters)

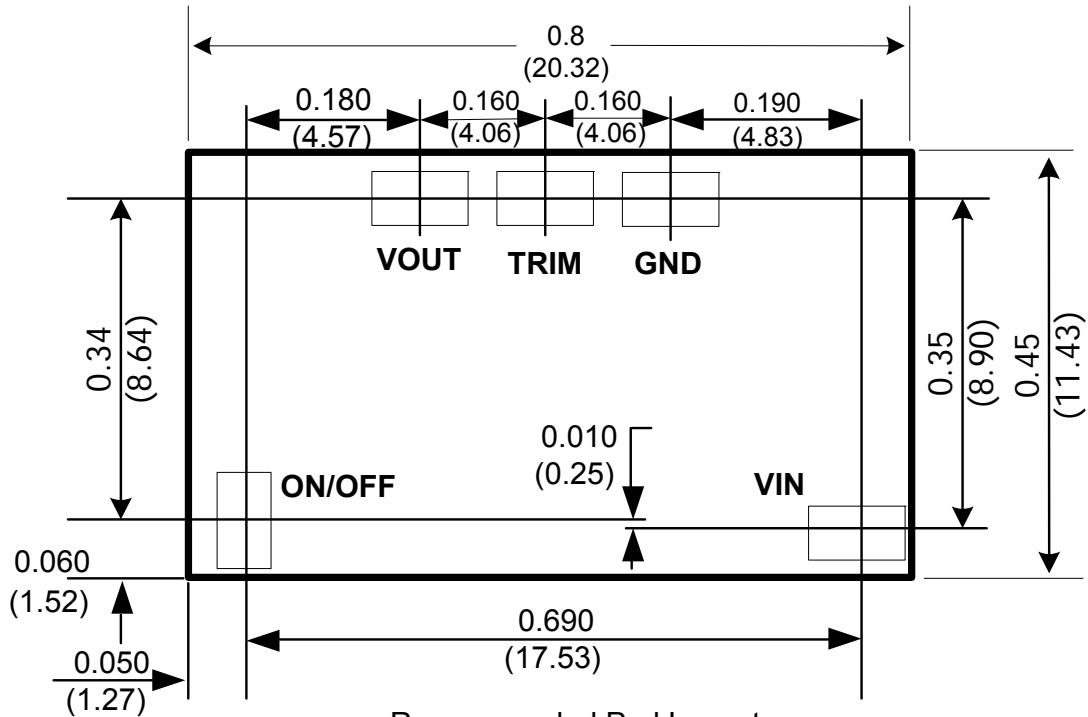

Recommended Pad Layout

Pad Size:

Min:0.120"x0.095"

Max:0.135"x0.110"

Component-side footprint

Application Notes