



Features

- Wide operating voltage: 3V ~ 5.5V
- Output Current up to 6A
- Output voltage ripple: 20mV_{PP}
- High Efficiency 94%
- Overcurrent /shortcircuit protection
- Over-temperature protection
- Remote on/off control-negative logic
- High reliability: designed to meet 5 million hour MTBF
- Minimal space on PCB:
- SMT Pin out
 - 20.32 mm x 6.7 mm x 11.43 mm or
 - 0.8 in x 0.265 in x 0.45in
- No derating to +75°C, natural convection
- UL/IEC/EN60950 compliant
- RoHS Compliant available

Applications

- Workstations, servers
- Desktop computers
- DSP applications
- Distributed power architectures
- Telecommunications equipment
- Data communications equipment
- Wireless communications equipment

Options

- Right angle pin for MQ7230SIP
- Positive logic control

Description

The **MicroTarzan™** MQ7230 Series Power Modules are non-isolated dc-dc converters that operate over a wide input voltage range of 3Vdc to 5.5Vdc and provide a precisely (2%) regulated dc output with industry standard SMT pin out. Such a module is suitable to application with 3.3V or 5V power supply bus. The modules have a maximum output current rating of 6A at a typical full-load efficiency over 94%. Standard features include remote on/off with negative logic and output voltage adjustment, over-current protection, over-temperature protection.

MQ7230 can load 6A in a very small size. This improves PCB layout and system integration capability

***** **Typical Application Circuit** *****

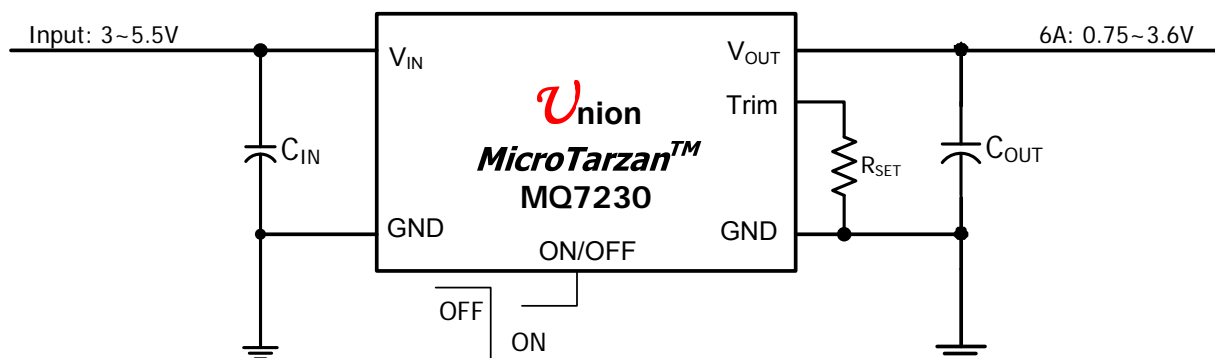

MicroTarzan™ MQ7230SMT

Performance Specifications (at TA=+25°C)

Model	Input V _{IN} Range (V)	Output				Efficiency (%)
		I _{OUT} (A)	Trim Range (V)	Regulation		
				Line (%)	Load (%)	
MQ7230SMT	3~5.5	6	0.75V~3.6V	0.5	0.5	94

Mechanical Specifications

Dimensions are in inches (mm)

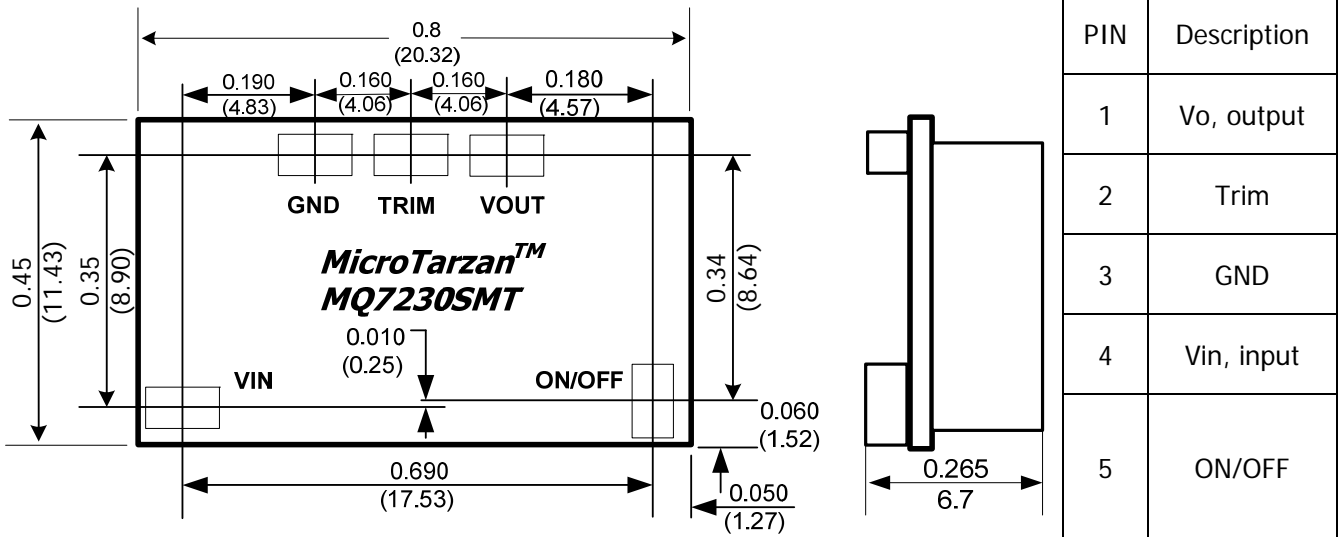

Ordering Information

MQ7230SMT1abcdPG

Union Microsystems
Power module P/N

SMT Package

Input Voltage Range
1:3.0~5.5V
2:8~14V

Green Product
(RoHS Compliant)

Positive Logic Control

Output Voltage
9999: for adjustable version
Abcd: a*10+b*1+c*0.1+d*0.01

For examples:

MQ7230SMT19999PG means MQ7230 in SMT Pin-out, input voltage 3~5.5V, output voltage 0.75~3.6V, positive logic control and green product.

MQ7230SMT20150G means MQ7230 in SMT Pin-out, input voltage 3~5.5V, output voltage 1.5V, negative logic control and green product.

Absolute Maximum Ratings

Note: These are stress ratings. Exposure of devices to any of these conditions may adversely affect long-term reliability. Proper operation under conditions other than those listed in the Performance Specifications Table is not implied.

Parameter	Symbol	Min	Max	Unit
Input Voltage	V_{IN}	-0.3	6	V
Storage Temperature	T_{STG}	-40	125	°C

MQ7230 Electrical Specifications: ($T_A=+25^\circ\text{C}$)

Parameter	Condition	Symbol	Min	Typ	Max	Unit
Input Voltage Range		V_{IN}	3.0		5.5	V
Output Current		I_o	0		6	A
Output Voltage Set point	100% load, $V_{IN}=V_{IN,MIN}$	ΔV_o	-2		+2	%
Output Trim Range	See Performance Specifications					
Line Regulation						
Load Regulation						
Temperature Regulation	$T_A = T_{A,MIN}$ To $T_{A,MAX}$	-		0.4		% $V_{O,SET}$
Output Ripple and Noise Voltage	$I_o=5A, 0\sim 20\text{MHz}$ (Detail Please see Ripple Figures, Page 7~21)					
Transient Response						

General Specifications

Parameter	Condition	Symbol	Min	Typ	Max	Unit
Maximum Capacitive Load	5A resistive load + Aluminum capacitor			5000		μF
	5A resistive load +Sanyo POSCAP			1000		
Overcurrent Protection			6.8		10	A
Output short-circuit current (average)	All		1		2	A
Under Voltage Lockout Trip Level	Rising and falling V_{IN} , 3% hysteresis		1.95	2.05	2.15	V
Positive Logic						
Input High Voltage (Module ON)		V_{IH}			$V_{IN,MAX}$	V
Input Low Voltage (Module OFF)		V_{IL}	-0.2		0.3	V
Negative Logic						
Input High Voltage (Module OFF)		V_{IH}	2		$V_{IN,MAX}$	V
Input Low Voltage (Module ON)		V_{IL}	-0.2		0.3	V
Start-up Time	5A resistive load, no external output capacitors			0.5		mS
Switching Frequency		F_o		300		kHz
Operating Temperature	Natural convection, no forced air flow		-40		85	°C
Vibration	3 Axes, 5 Min Each	10~55Hz, 0.35mm, 5g				
	3 Axes, 6 Times Each	Peak Deviation 300g, Settling Time 6mS				
MTBF			5,000,000			Hour

Test Configurations

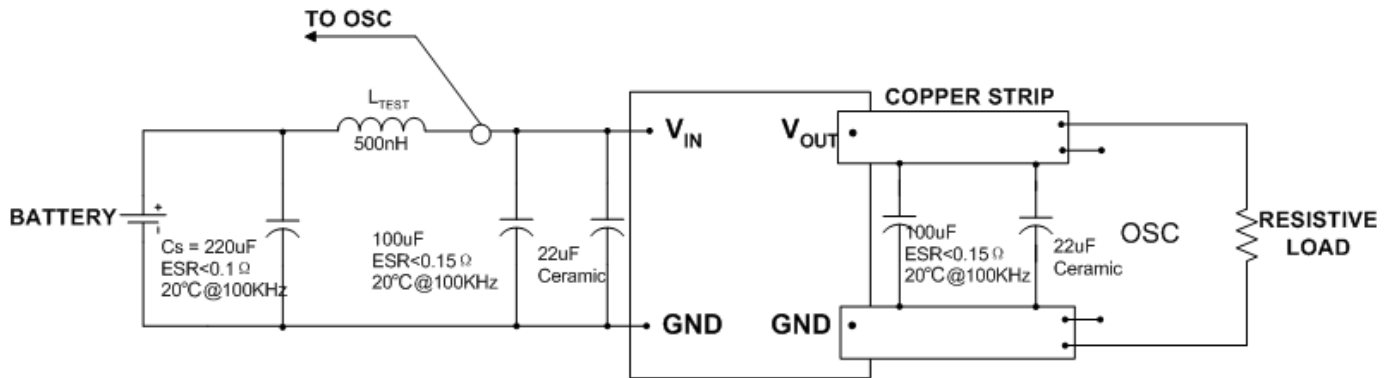

Test setup for input noise, output noise and ripple

Note:

Output noise is measured with 0.1µ F ceramic capacitor connected at the output. OSC measurement should be made using a BNC socket. Position the load between 50mm and 75mm (2in. and 3in) from the tested module.

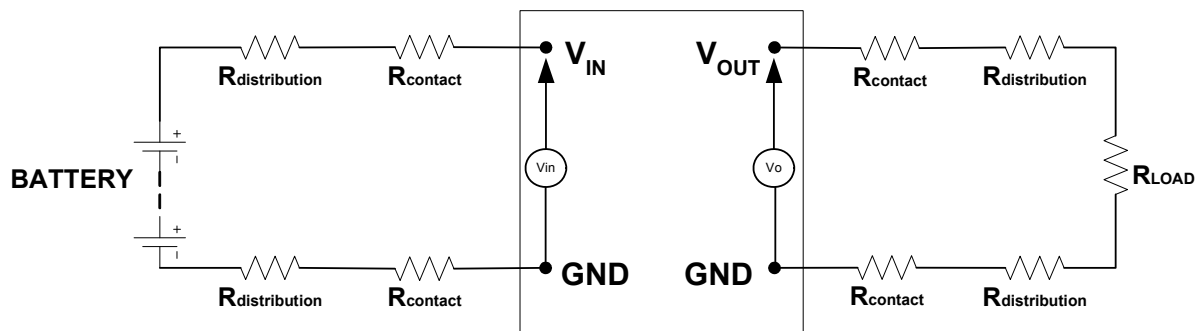

Test setup for efficiency

Note:

All voltage measurements must be taken at the module's terminals, as shown above. If sockets are needed, Kelvin connections are required at the module terminals to avoid measurement errors due to socket contact resistance.

Technical Notes

Input Voltage Range

The MQ7230 Series can be used in a wide variety of applications, esp. most of 3.3V or 5V power supply bus system. So, when system voltage transferred from 5V to 3.3V or vice versa, no redesign needed which simplifies design, speeds the time to market and adds flexibility to system.

Return Current Paths

The MQ7230 Series is non-isolated DC/DC converters. Their input and output shares same Common pins. To the extent possible with the intent of minimizing ground loops, input/output return current should be directed the Common pins as short as possible.

I/O Filtering

All the specifications of the MQ7230 Series are tested and specified without output capacitors. However, certain input capacitors are necessary to improve the power modules' operating conditions and to reduce the ac impedance. For example, under some conditions, the power modules can't normally start up when fully loaded due to the high ac-impedance input source. External input capacitors serve primarily as energy-storage devices. They should be added close to the input pins of the MQ7230 and selected for bulk capacitance (at appropriate frequencies), low ESR, and high rms-ripple-current ratings. All external capacitors should have appropriate voltage ratings. To reduce the amount of ripple current fed back to the input supply (input reflected-ripple current), an external L-C filter can be added with the inductance as close to the power module as possible.

MQ7230's output ripple and transient response can be improved with the increasing output capacitance. When using output capacitors, take care that the total output capacitance does not exceed MQ7230's Maximum Capacitive Load to avoid the module's protection condition in the start-up.

When an external L-C filter is added to reduce ripple on load, for best results, the filter components should be mounted close to the load circuit rather than the power module.

When testing the relationship between external capacitors and output voltage noise, the oscilloscope's probe should be applied to the module's end directly with scope probe ground less than 10mm in length.

Input Fusing

The MQ7230 Series is not internally fused. Certain applications and/or safety agencies may require the installation of fuses at the inputs of power conversion components. The selection of the fuses should conform to the following:

1. The fuse value should be fast-blow 6A fuses.
2. Both input traces must be capable of carrying a current of 1.5 times the value of the fuse without opening.

Safety Considerations

MQ7230's are non-isolated DC/DC converters. In general, all DC-DC's must be installed in compliance with relevant safety-agency specifications (usually UL/IEC/EN60950). In particular, for a non-isolated converter's output voltage to meet SELV (safety extra low voltage) requirements, its input must be SELV compliant. If the output needs to be ELV (extra low voltage), the input must be ELV.

ON/OFF Control

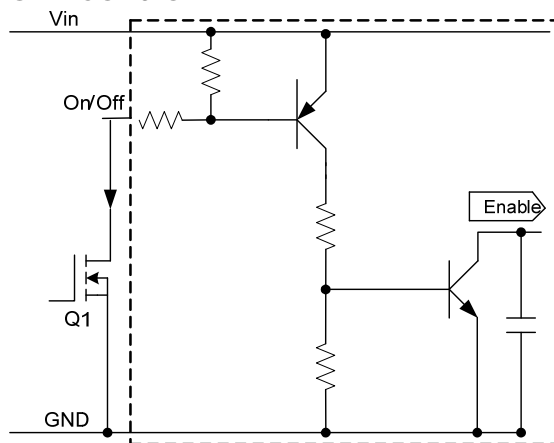

Fig1a. Circuit configuration for using Positive logic On/OFF

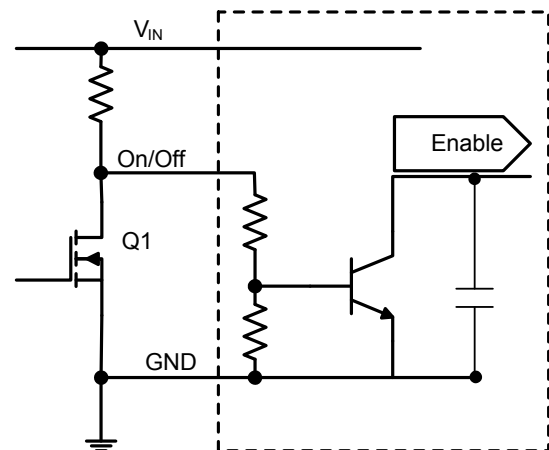

Fig1b. Circuit configuration for using negative logic On/OFF

For positive logic modules, the circuit configuration for using On/Off pin is shown in Fig1a. The On/Off pin is an open collector/drain logic input signal ($V_{on/Off}$) that is referenced to ground. During a logic-high (On/Off pin is pulled high internal to the module) when the Q1 is in the Off state, the power module is ON. Applying a logic-low when the transistor Q1 is turned-On, the power module is Off.

For negative logic On/Off devices, the circuit configuration is shown in Fig1b. The On/Off pin is pulled high with an external pull-up resistor. When transistor Q1 is in Off state, logic High is applied to the On/Off pin and the power is Off. The minimum On/off voltage for logic High on the On/Off pin is 2.5Vdc. To turn the module ON, logic low is applied to the On/Off pin by turning on Q1

The regulator will run in normal operation when the ON/OFF pin is left open.

Output Overvoltage Protection

MQ7230 Series products do not incorporate output overvoltage protection. If the operating circuit requires protection against abnormal output voltage, voltage-limiting circuitry must be provided external to the power module.

Output Overcurrent Protection (OCP)

MQ7230 incorporates overcurrent and short circuit protection. If the load current exceeds the overcurrent protection setpoint, the MQ7230's internal overcurrent-protection circuitry immediately turns off the module, which then goes into Hiccup mode. The unit operates normally once the output current is brought back into its specified range. The typical average output current during hiccup is 1~2A.

Caution: Be careful never to operate MQ7230 in a "heavy overload" condition that is between the rated output current and the overcurrent protection setpoint. This can cause permanent damage to the components.

Overtemperature Protection (OTP)

To ensure MQ7230's reliability and avoid damaging its internal components, MQ7230 incorporates overtemperature protection circuit. When the temperature of the PCB is above 130°C, the overtemperature protection circuit will be enabled and the module will stop working. when the temperature of the temperature-testing component is below about 80°C, the overtemperature protection circuit will release and the module will automatically recover from shutdown. To avoid permanently damaging components, the surface temperature of MQ7230's power components, esp. of the MOSFET should be ensured below 120°C.

Note: The overtemperature protection may be issued when MQ7230 operates in a "heavy overload" condition for a long time. Thus, the air flow should be improved.

Output Voltage Trimming

MQ7230's output voltage can be trimmed in certain ranges. See Figure 2 for the 2 programming methods. See Performance Specifications for allowable trim ranges in detail. Also customized products are offered.

Trim with external resistor (Fig3a), the equation as below:

$$R_{TRIM} = \frac{21070}{V_o - 0.7525} - 5110$$

Resistor values are in Ω; V_O is desired output voltage.

For examples, to trim output to 1.5V, then

$$R_{TRIM} = \frac{21070}{1.5 - 0.7525} - 5110 = 23077$$

So, R_{TRIM} = 23.077kΩ

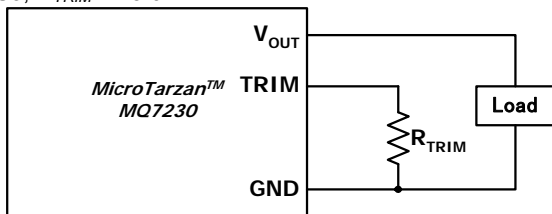

Fig2a. Circuit configuration for programming output voltage using external resistor

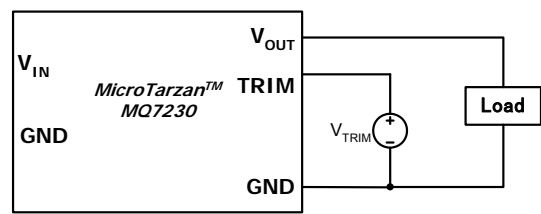

Fig2b. Circuit configuration for programming output voltage using external voltage source

Fig2, Program output voltage by external resistor or voltage source

And the voltage can be programmed by using an external voltage source (Fg2b), the equation as below:

$$V_{TRIM} = 0.7 - 0.1698 \times (V_o - 0.7525)$$

V_{TRIM} values are in Volt; V_O is desired output voltage.

For examples to trim output to 1.5V, then

$$V_{TRIM} = 0.7 - 0.1698 \times (1.5 - 0.7525) = 0.5731$$

So, V_{TRIM} = 0.5731V

For most common voltages, the required Trim resistors and voltages as Table 1.

Table 1, the required trim resistors R_{TRIM} and Trim voltages V_{TRIM} for most common voltages

Desired Voltages (V)	R_{TRIM} (k Ω)	V_{TRIM} (V)
0.7525	OPEN	OPEN
1.0	85.126	0.6580
1.2	41.973	0.6240
1.5	23.077	0.5731
1.8	15.004	0.5221
2.5	6.947	0.4033
3.3	3.160	0.2670

Typical Characteristics – output adjusted to 0.75V

General conditions:

Input filter 22µF Ceramic + 100µF TAN (150mΩ ESR), Output filter 22µF Ceramic + 100µF TAN (150mΩ ESR)

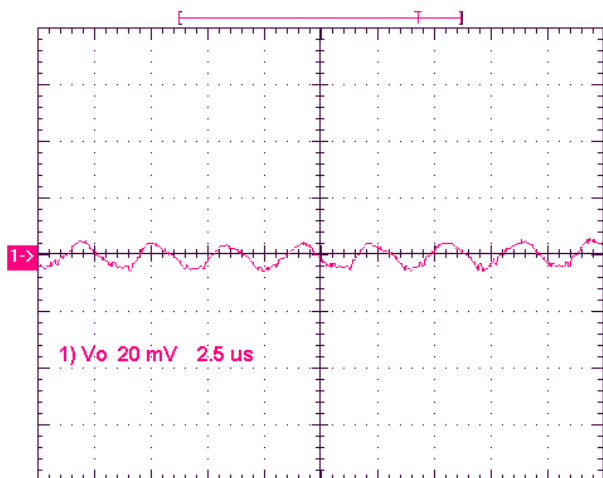

Noise $V_{IN}=5V$, $I_O=5A$, 5~20MHz Bandwidth

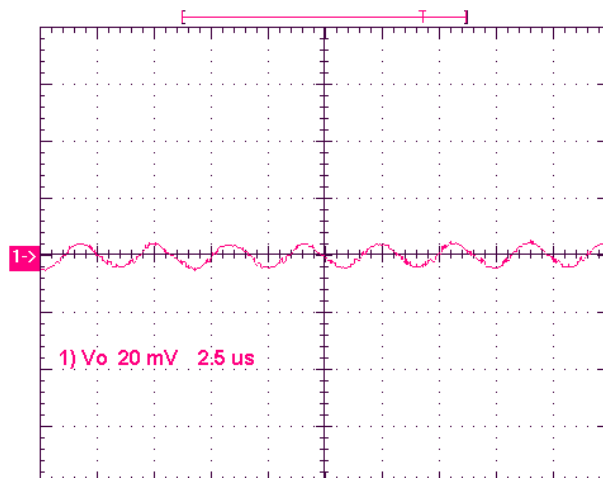

Noise $V_{IN}=3.3V$, $I_O=5A$, 5~20MHz Bandwidth

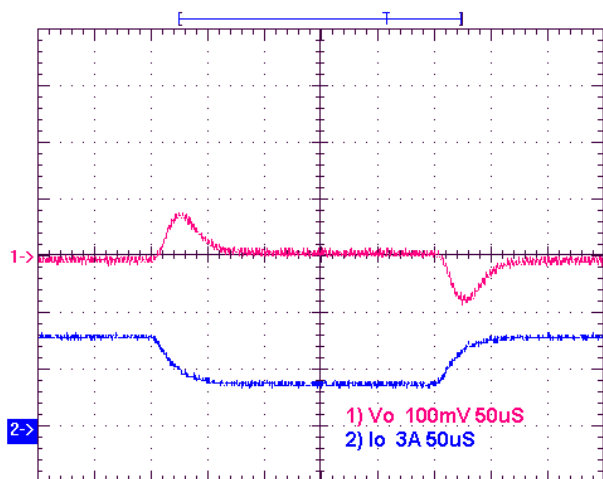

Transient Response $V_{IN}=5V$, Step from 5A~2.5A~5A

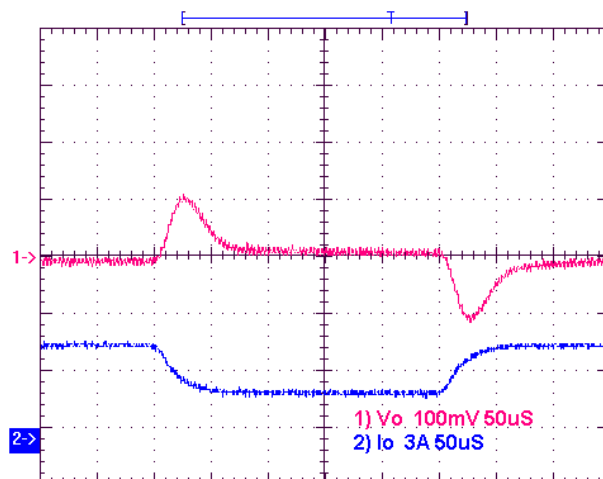

Transient Response $V_{IN}=3.3V$, Step from 5A~2.5A~5A

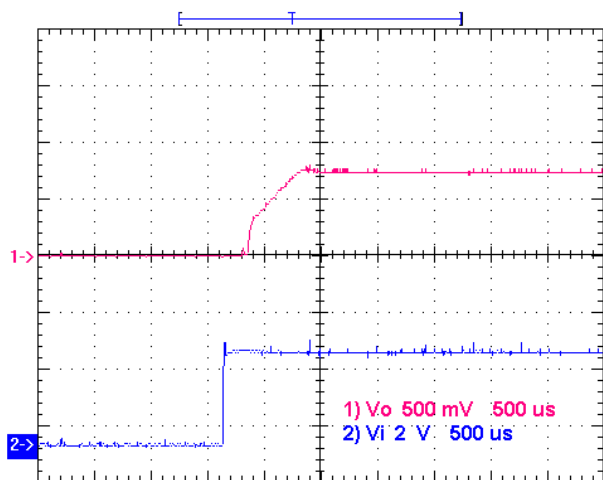

Start-up $V_{IN}=3.3V$, $I_O=5A$

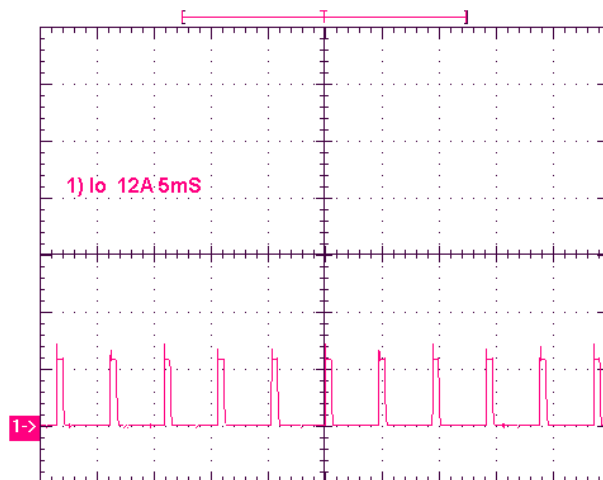

Short-Circuit Output $V_{IN}=3.3V$

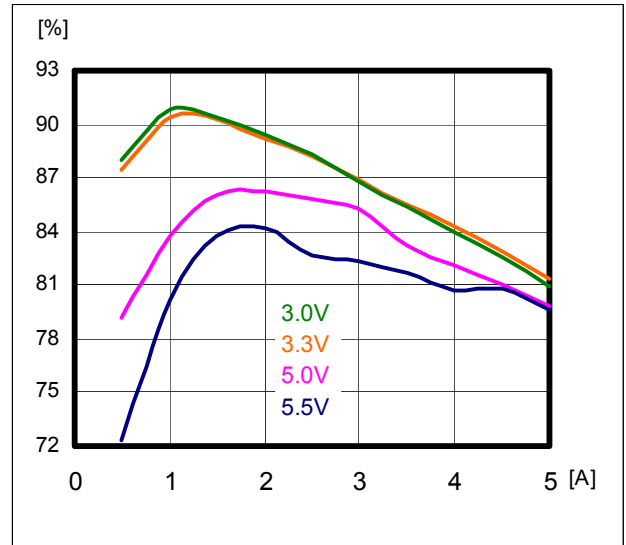
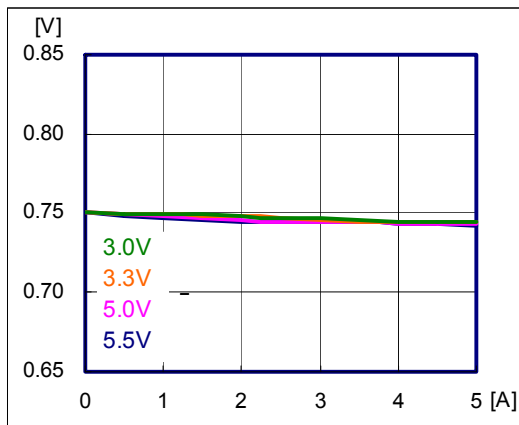

Regulation
Output voltage vs. Load Current,

Efficiency

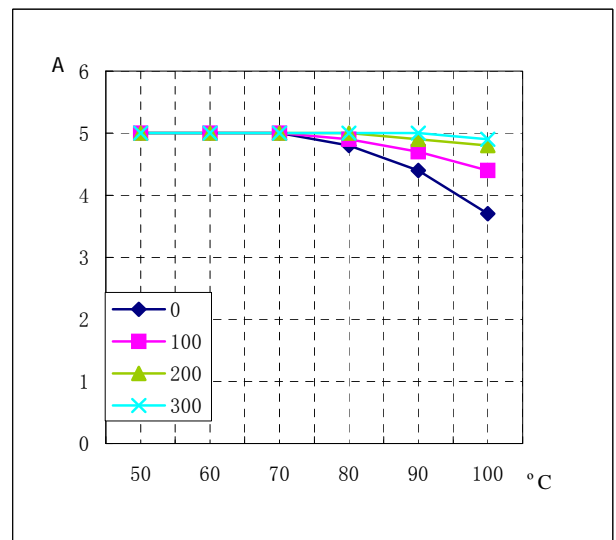
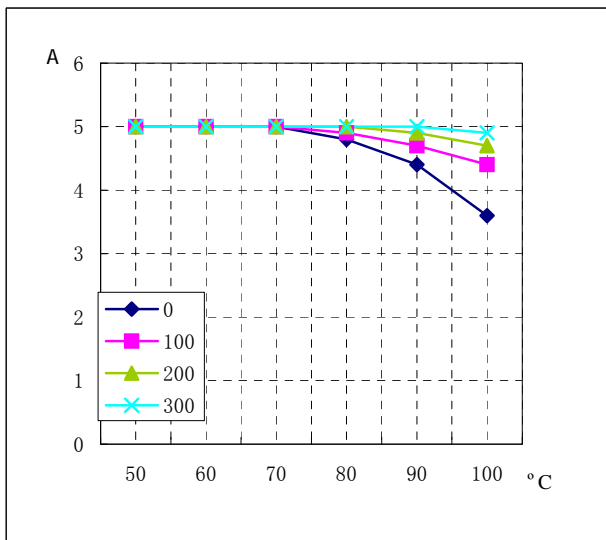

Output Current Derating (Load Current vs. Ambient Temperature), $V_{IN}=5V$,

Output Current Derating (Load Current vs. Ambient Temperature), $V_{IN}=3.3V$

Typical Characteristics – output adjusted to 1V

General conditions:

Input filter 22µF Ceramic + 100µF TAN (150mΩ ESR), Output filter 22µF Ceramic + 100µF TAN (150mΩ ESR)

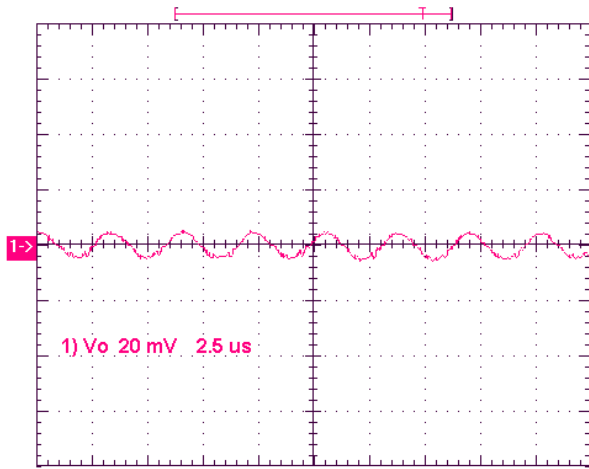

Noise $V_{IN}=5V$, $I_O=5A$, 5~20MHz Bandwidth

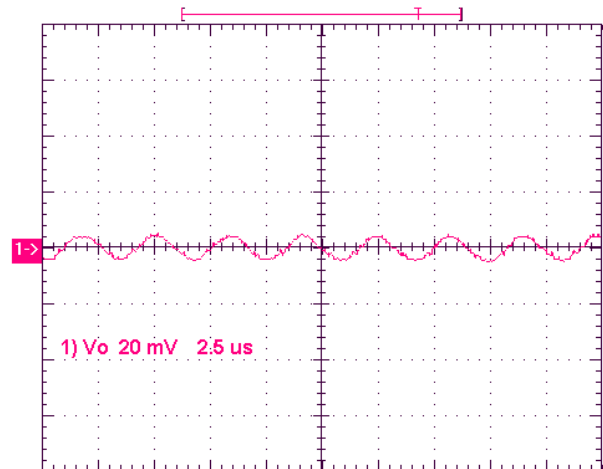

Noise $V_{IN}=3.3V$, $I_O=5A$, 5~20MHz Bandwidth

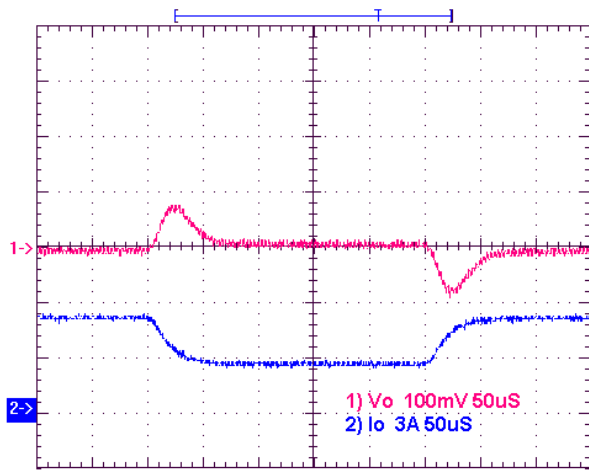

Transient Response $V_{IN}=5V$, Step from 5A~2.5A~5A

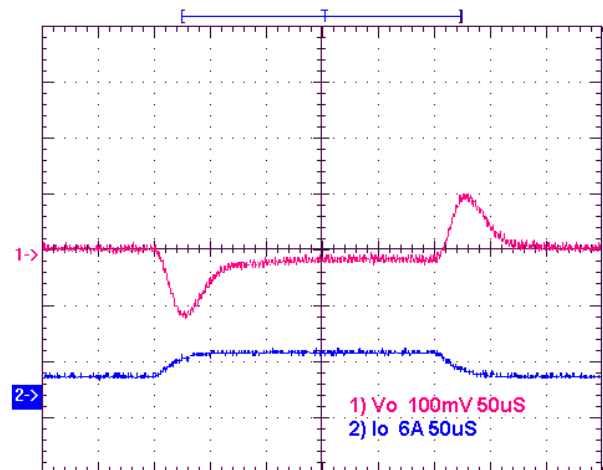

Transient Response $V_{IN}=3.3V$, Step from 5A~2.5A~5A

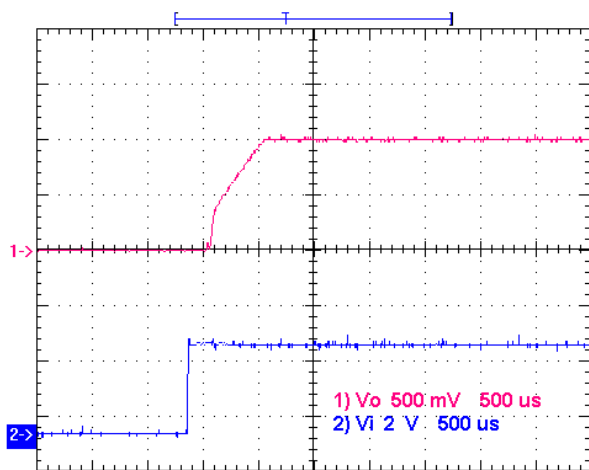

Start-up $V_{IN}=3.3V$, $I_O=5A$

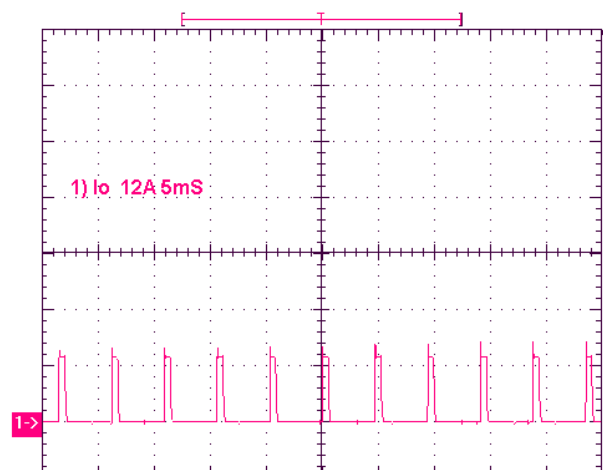

Short-Circuit Output $V_{IN}=3.3V$

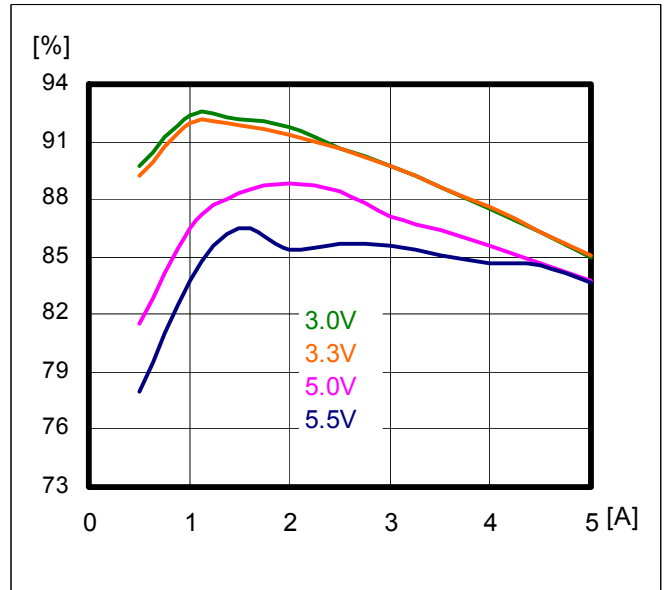
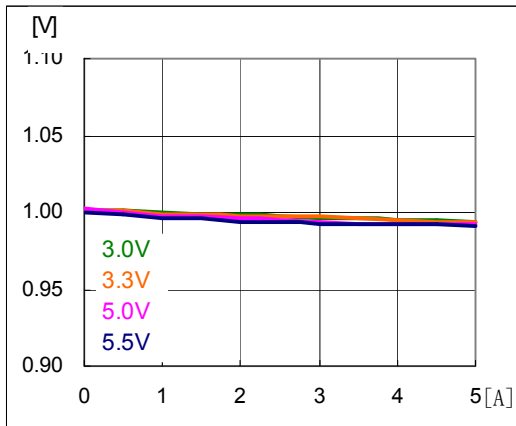

Regulation
Output voltage vs. Load Current,

Efficiency

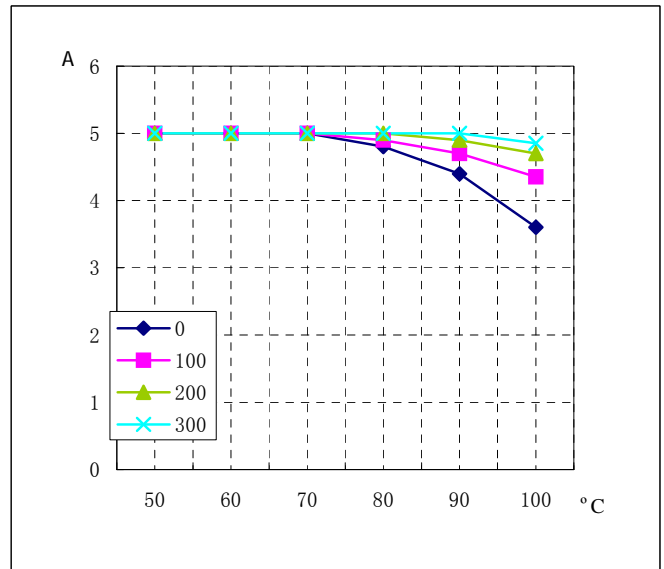
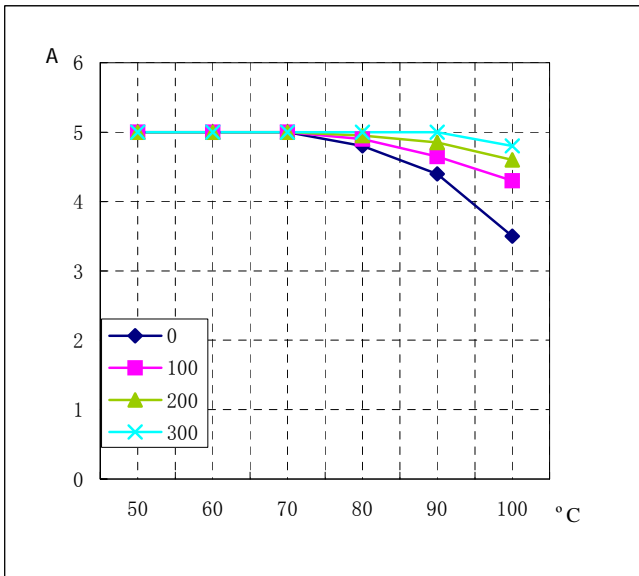

Output Current Derating (Load Current vs. Ambient Temperature), $V_{IN}=5V$,

Output Current Derating (Load Current vs. Ambient Temperature), $V_{IN}=3.3V$

Typical Characteristics – output adjusted to 1.2V

General conditions:

Input filter 22µF Ceramic + 100µF TAN (150mΩ ESR), Output filter 22µF Ceramic + 100µF TAN (150mΩ ESR)

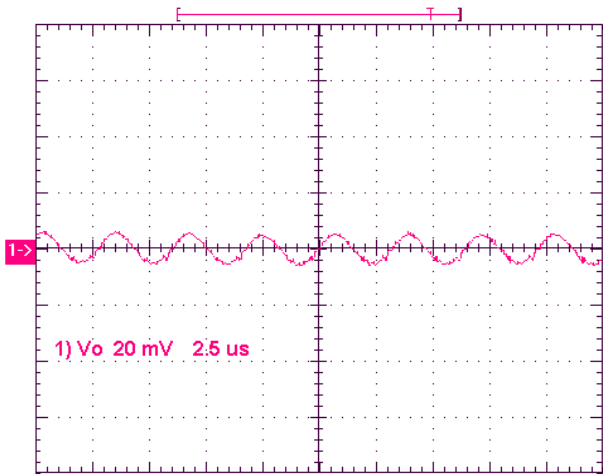

Noise $V_{IN}=5V$, $I_O=5A$, 5~20MHz Bandwidth

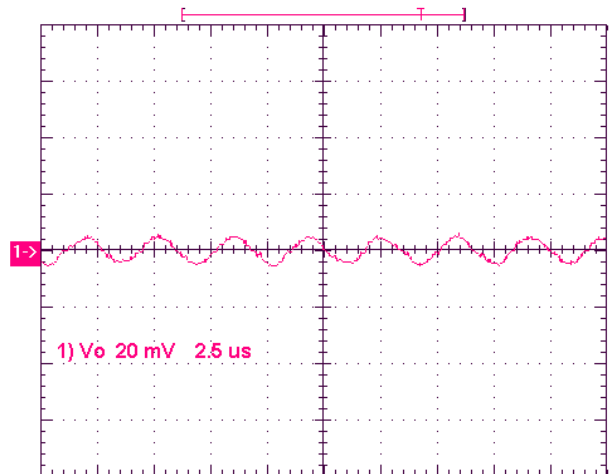

Noise $V_{IN}=3.3V$, $I_O=5A$, 5~20MHz Bandwidth

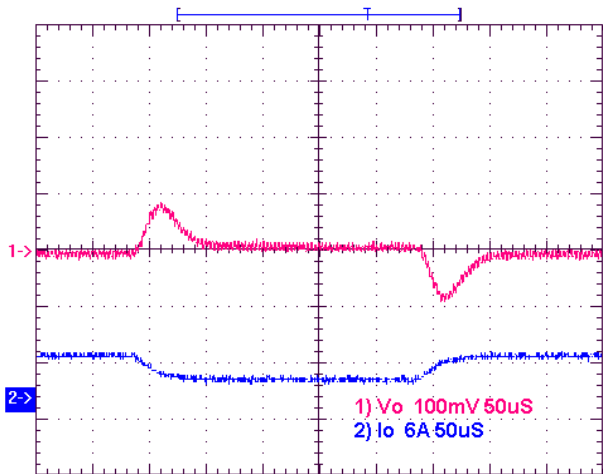

Transient Response $V_{IN}=5V$, Step from 5A~2.5A~5A

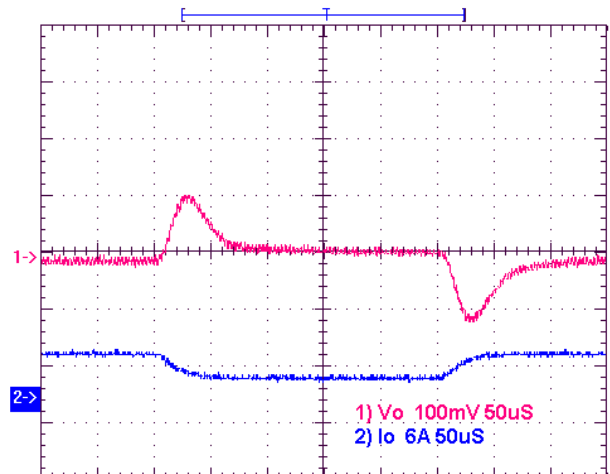

Transient Response $V_{IN}=3.3V$, Step from 5A~2.5A~5A

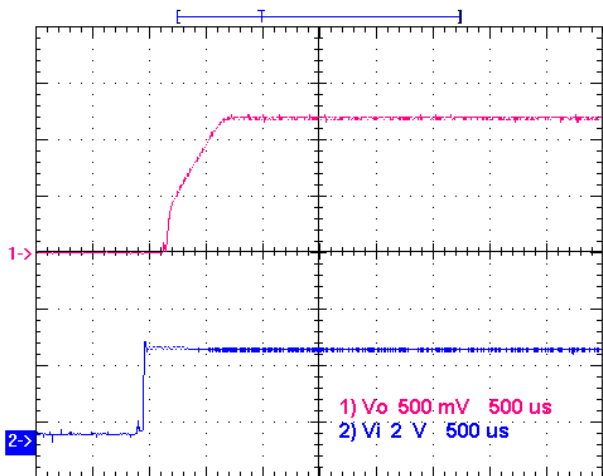

Start-up $V_{IN}=3.3V$, $I_O=5A$

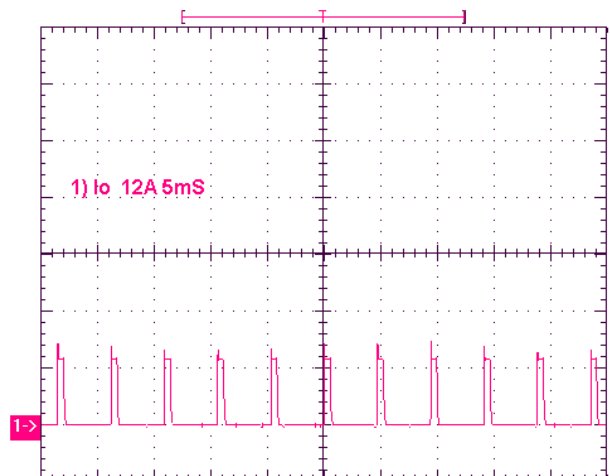

Short-Circuit Output $V_{IN}=3.3V$

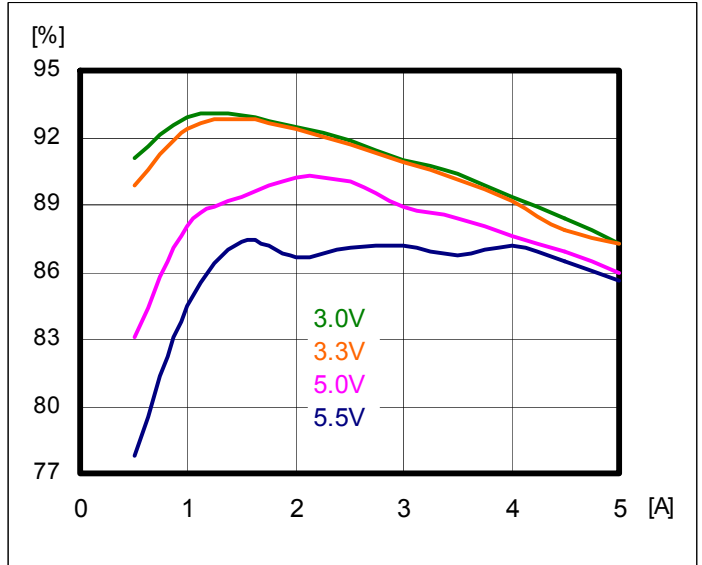
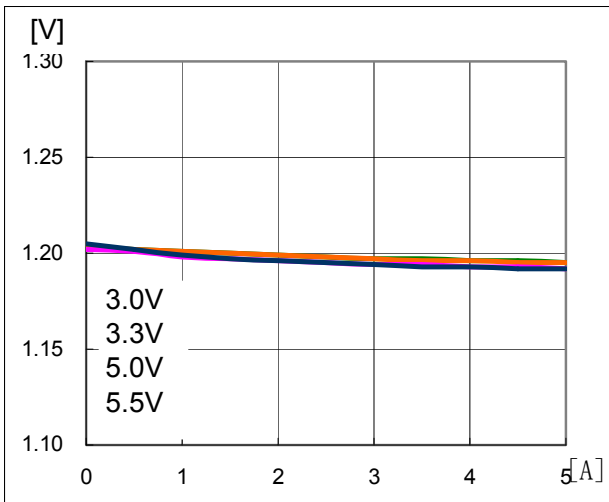

Regulation
Output voltage vs. Load Current,

Efficiency

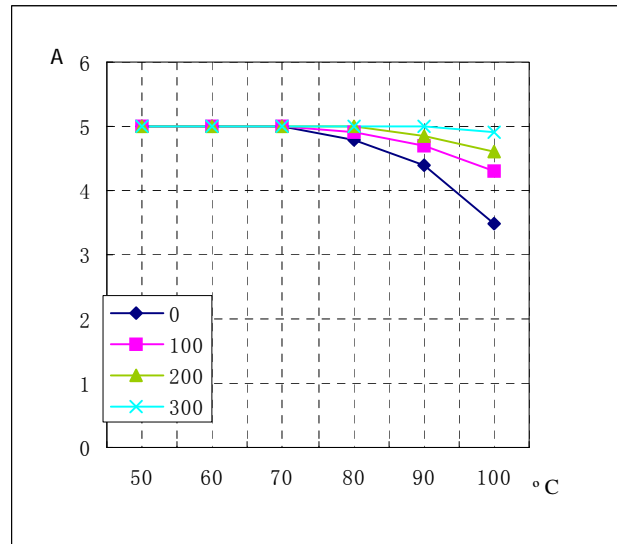
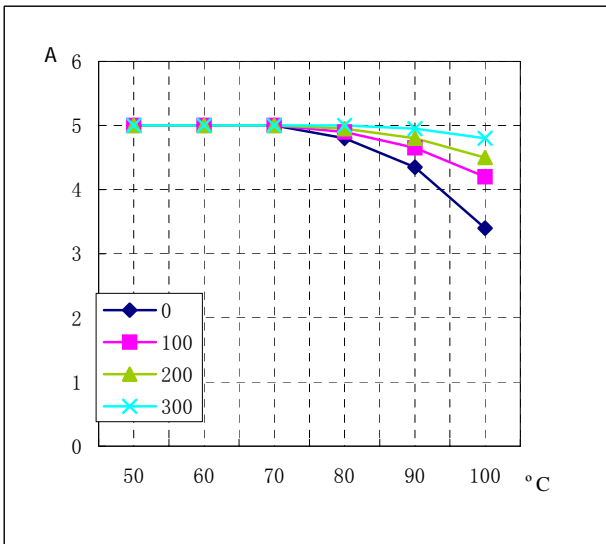

Output Current Derating (Load Current vs. Ambient Temperature), $V_{IN}=5V$,

Output Current Derating (Load Current vs. Ambient Temperature), $V_{IN}=3.3V$

Typical Characteristics – output adjusted to 1.5V

General conditions:

Input filter 22µF Ceramic + 100µF TAN (150mΩ ESR), Output filter 22µF Ceramic + 100µF TAN (150mΩ ESR)

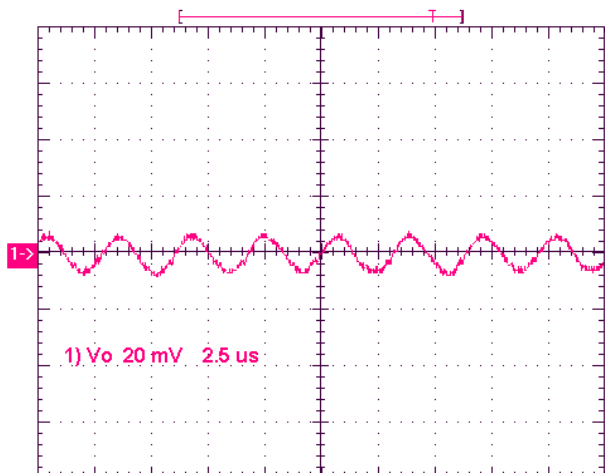

Noise $V_{IN}=5V$, $I_O=5A$, 5~20MHz Bandwidth

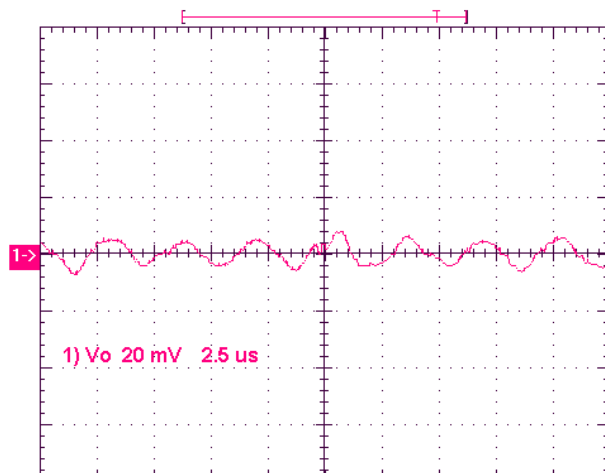

Noise $V_{IN}=3.3V$, $I_O=5A$, 5~20MHz Bandwidth

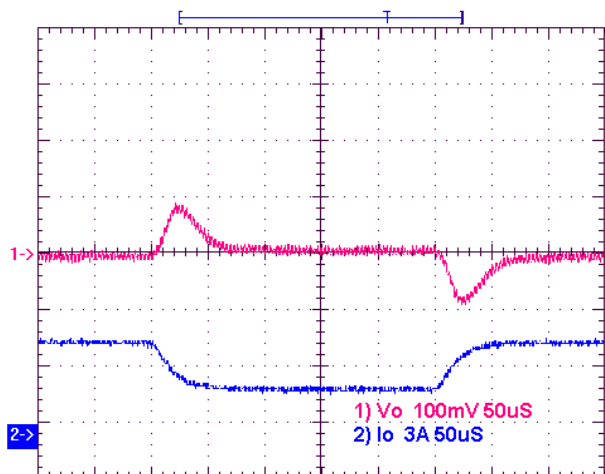

Transient Response $V_{IN}=5V$, Step from 5A~2.5A~5A

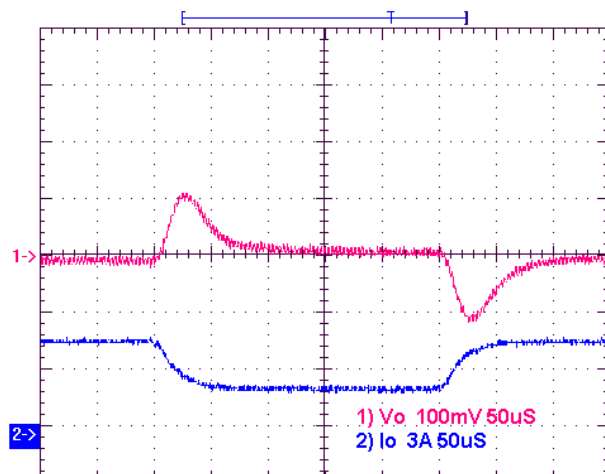

Transient Response $V_{IN}=3.3V$, Step from 5A~2.5A~5A

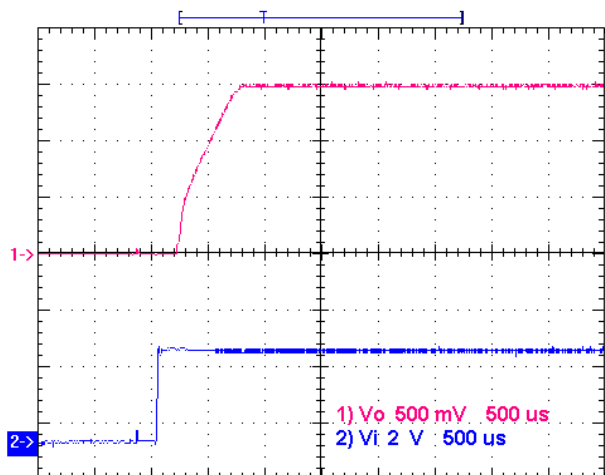

Start-up $V_{IN}=3.3V$, $I_O=5A$

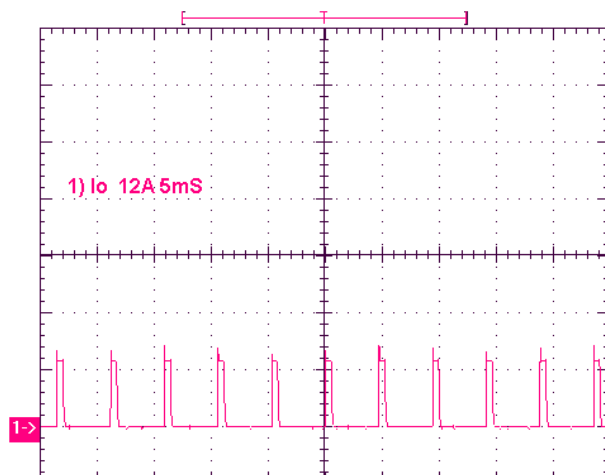

Short-Circuit Output $V_{IN}=3.3V$

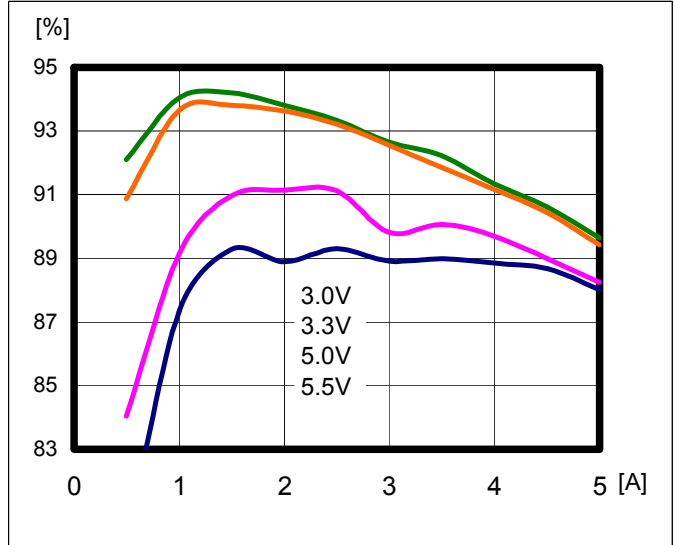
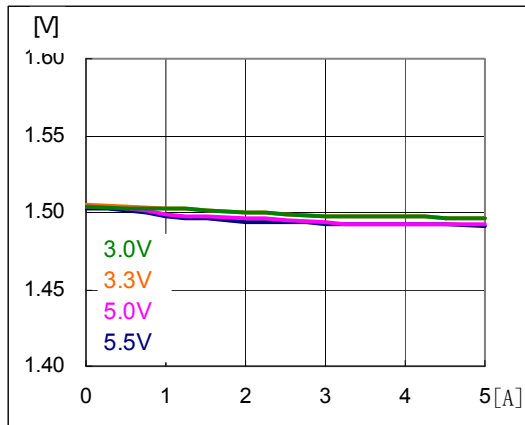

Regulation
Output voltage vs. Load Current,

Efficiency

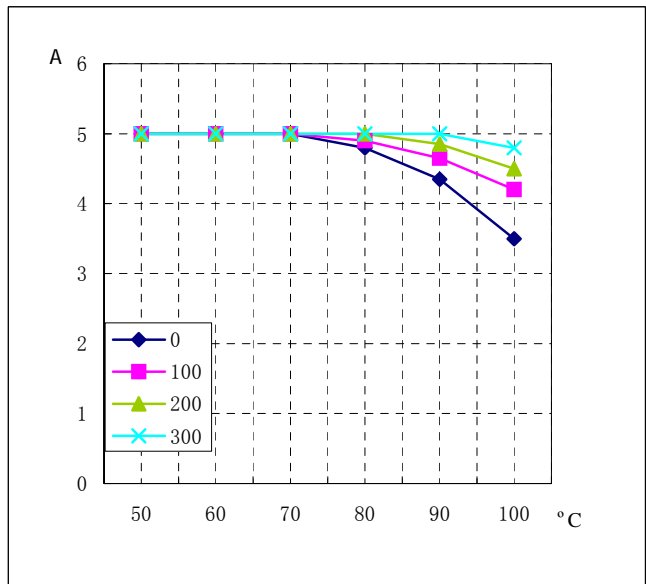
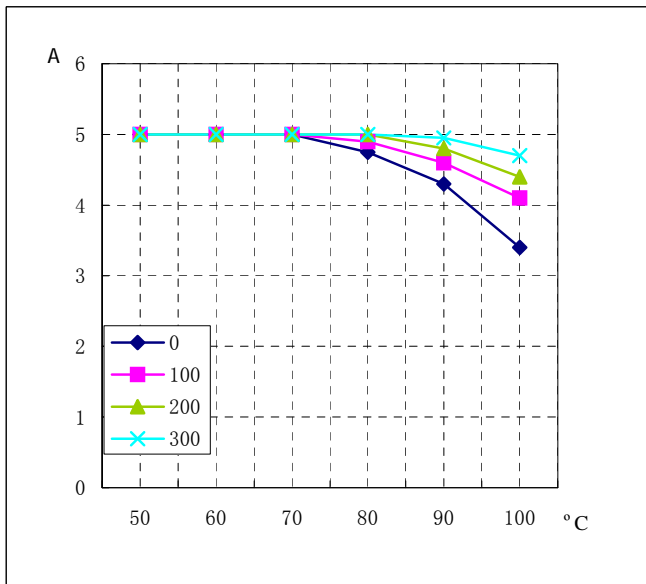

Output Current Derating (Load Current vs. Ambient Temperature), $V_{IN}=5V$,

Output Current Derating (Load Current vs. Ambient Temperature), $V_{IN}=3.3V$

Typical Characteristics – output adjusted to 1.8V

General conditions:

Input filter 22µF Ceramic + 100µF TAN (150mΩ ESR), Output filter 22µF Ceramic + 100µF TAN (150mΩ ESR)

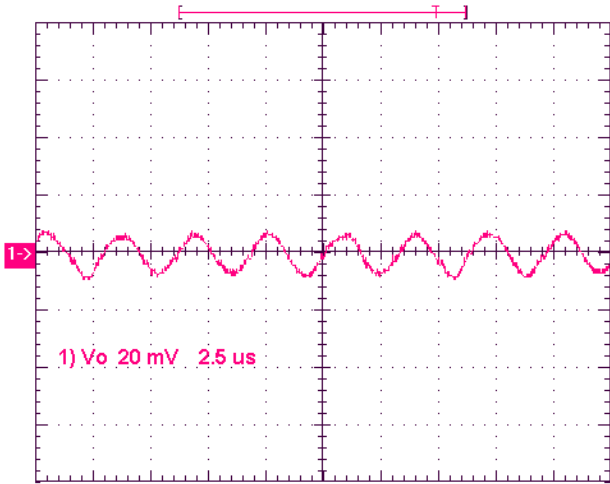

Noise $V_{IN}=5V$, $I_O=5A$, 5~20MHz Bandwidth

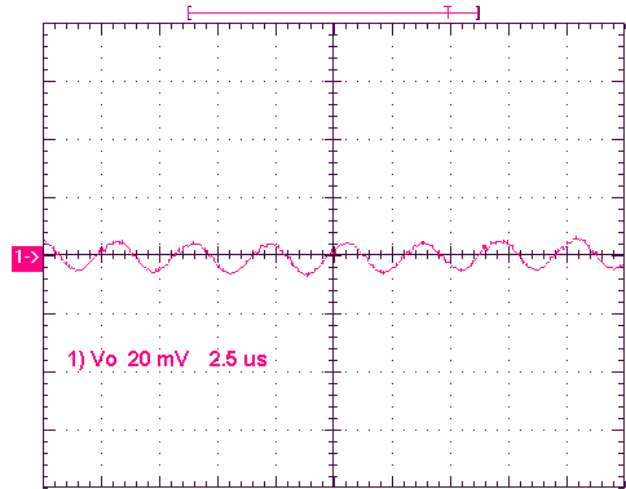

Noise $V_{IN}=3.3V$, $I_O=5A$, 5~20MHz Bandwidth

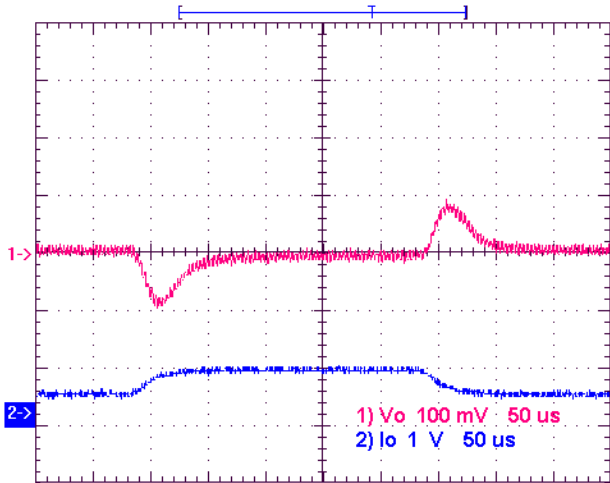

Transient Response $V_{IN}=5V$, Step from 5A~2.5A~5A

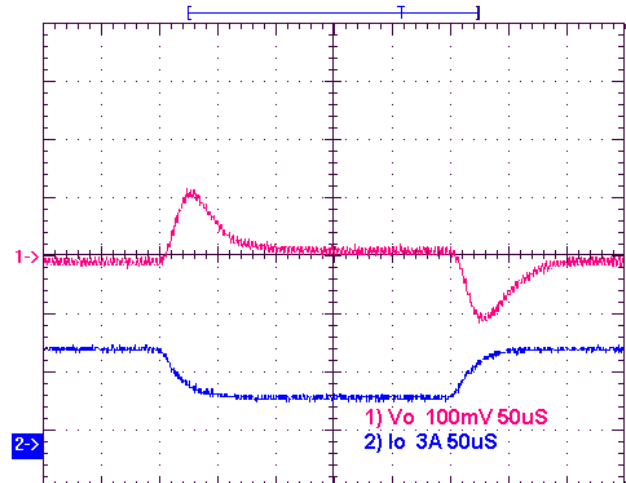

Transient Response $V_{IN}=3.3V$, Step from 5A~2.5A~5A

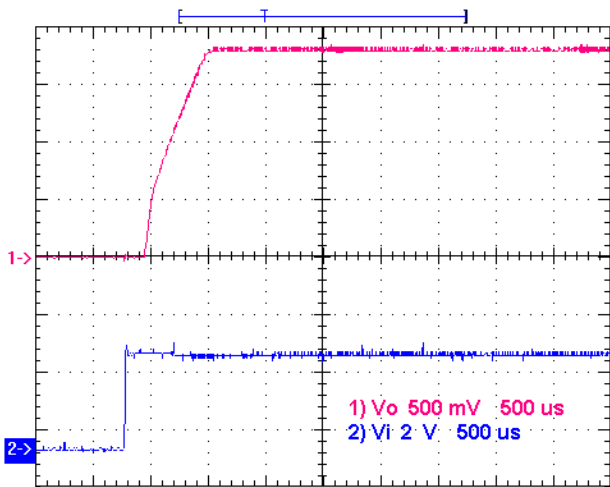

Start-up $V_{IN}=3.3V$, $I_O=5A$

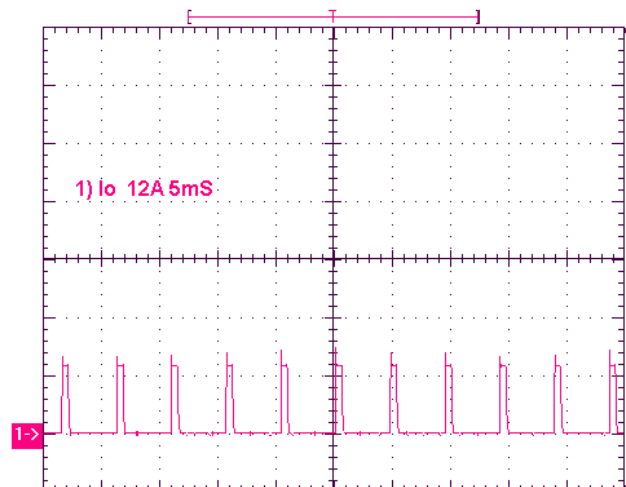

Short-Circuit Output $V_{IN}=3.3V$

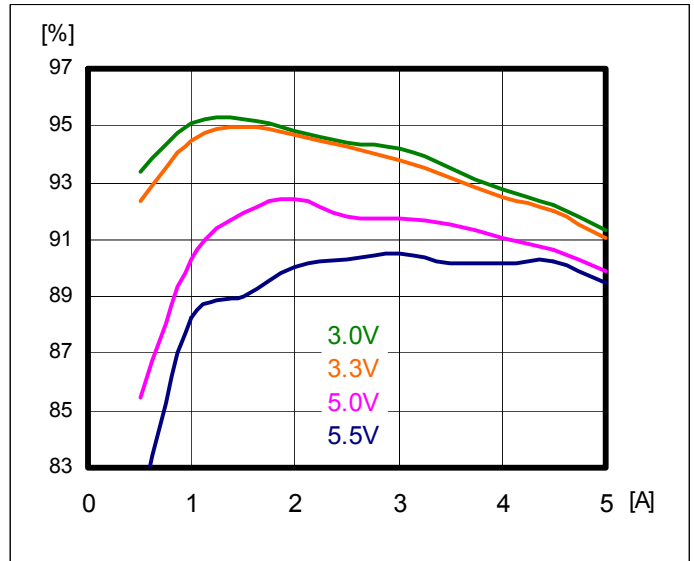
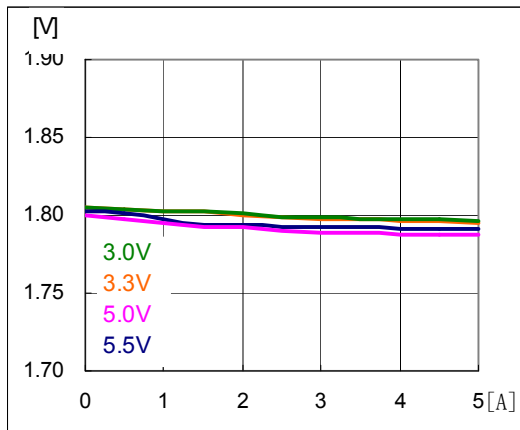

Regulation
Output voltage vs. Load Current,

Efficiency

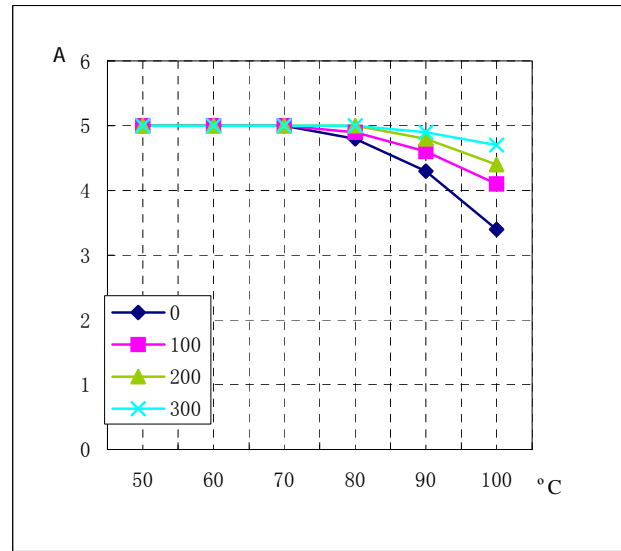
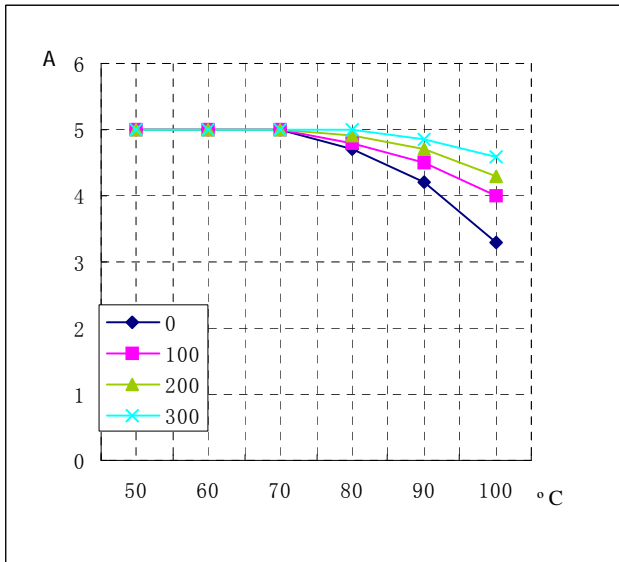

Output Current Derating (Load Current vs. Ambient Temperature), $V_{IN}=5V$,

Output Current Derating (Load Current vs. Ambient Temperature), $V_{IN}=3.3V$

Typical Characteristics – output adjusted to 2.5V

General conditions:

Input filter 22µF Ceramic + 100µF TAN (150mΩ ESR), Output filter 22µF Ceramic + 100µF TAN (150mΩ ESR)

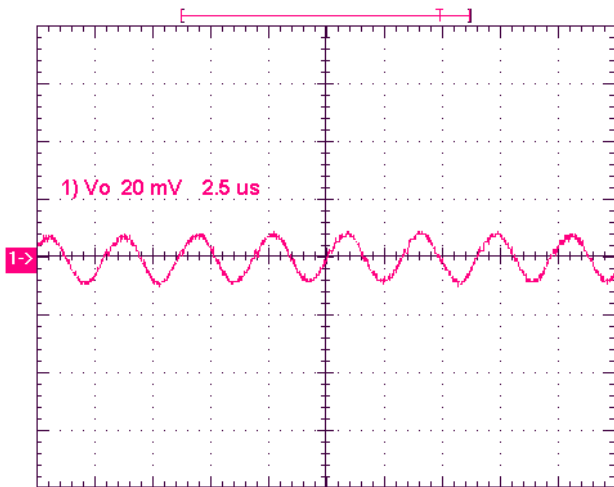

Noise $V_{IN}=5V$, $I_O=5A$, 5~20MHz Bandwidth

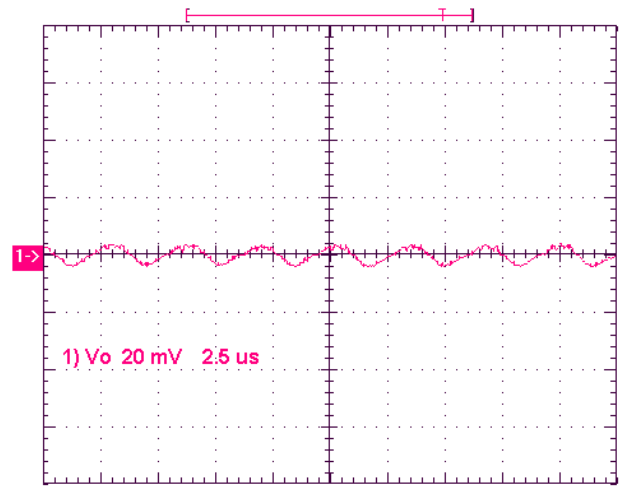

Noise $V_{IN}=3.3V$, $I_O=5A$, 5~20MHz Bandwidth

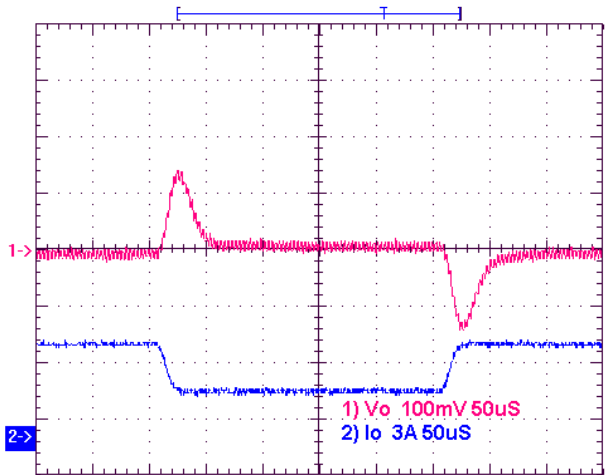

Transient Response $V_{IN}=5V$, Step from 5A~2.5A~5A

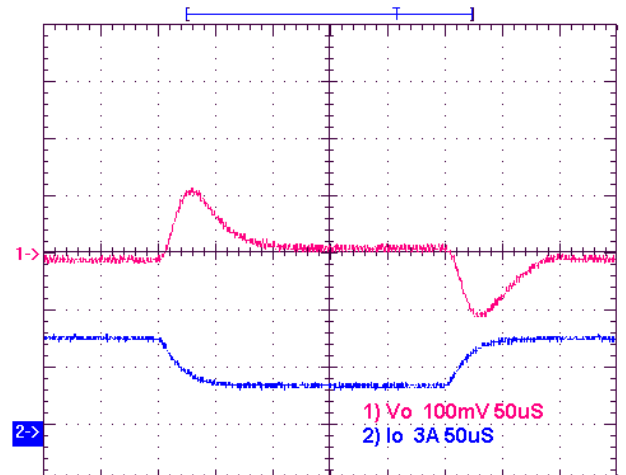

Transient Response $V_{IN}=3.3V$, Step from 5A~2.5A~5A

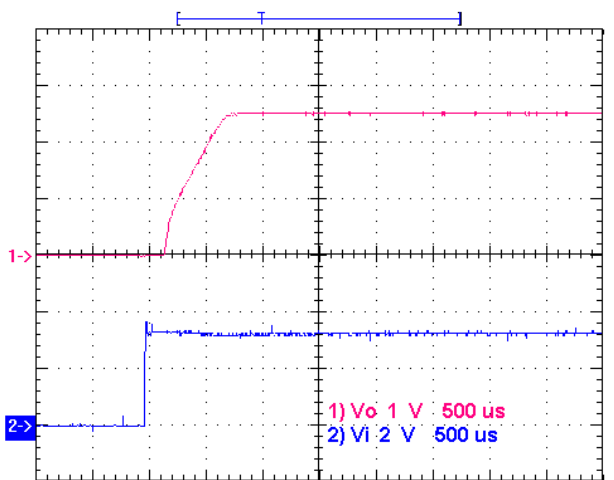

Start-up $V_{IN}=3.3V$, $I_O=5A$

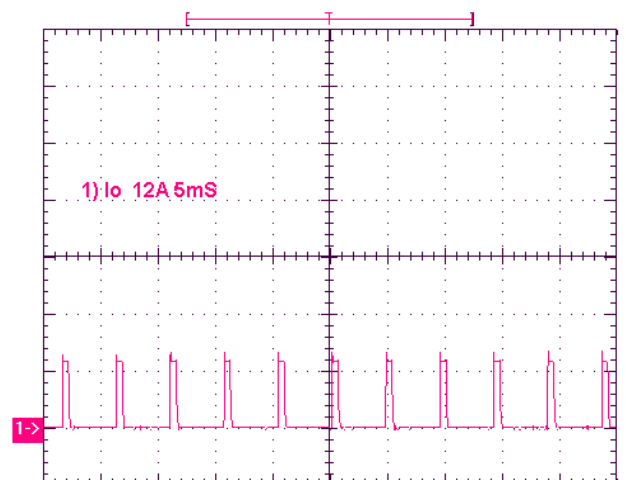

Short-Circuit Output $V_{IN}=3.3V$

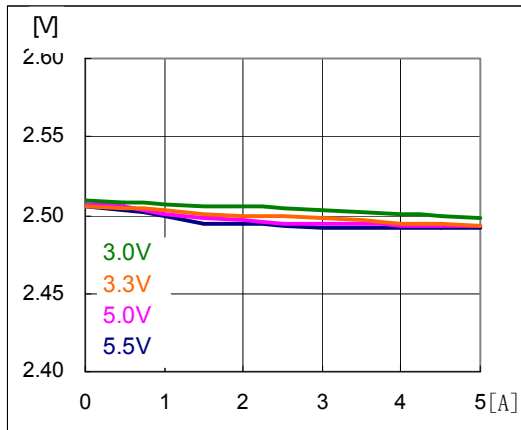

Regulation
Output voltage vs. Load Current,

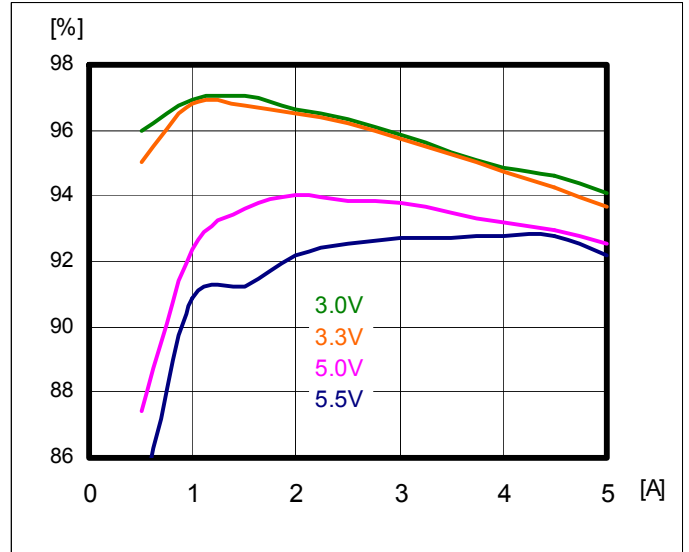

Efficiency

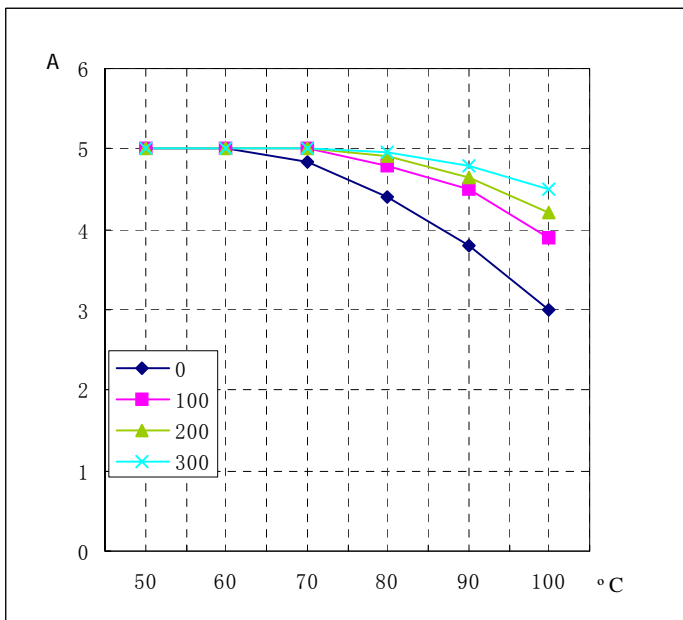

Output Current Derating (Load Current vs. Ambient Temperature), $V_{IN}=5V$,

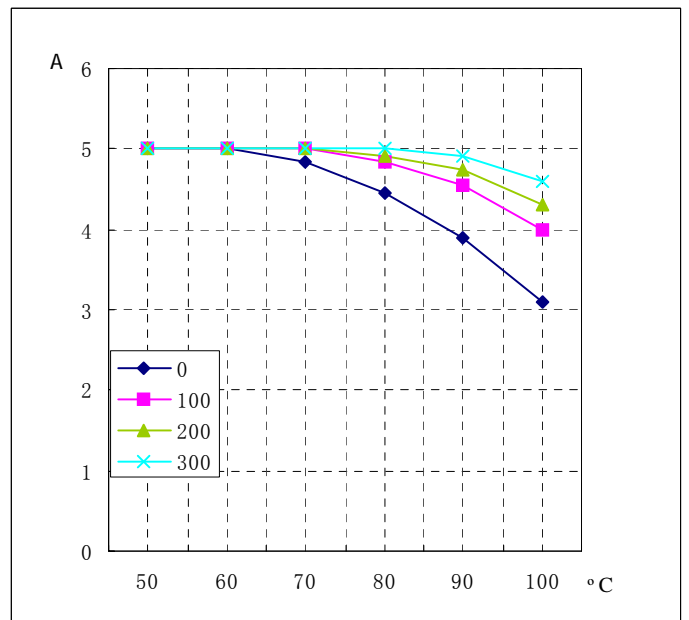

Output Current Derating (Load Current vs. Ambient Temperature), $V_{IN}=3.3V$

Typical Characteristics – output adjusted to 3.3V

General conditions:

Input filter 22µF Ceramic + 100µF TAN (150mΩ ESR), Output filter 22µF Ceramic + 100µF TAN (150mΩ ESR)

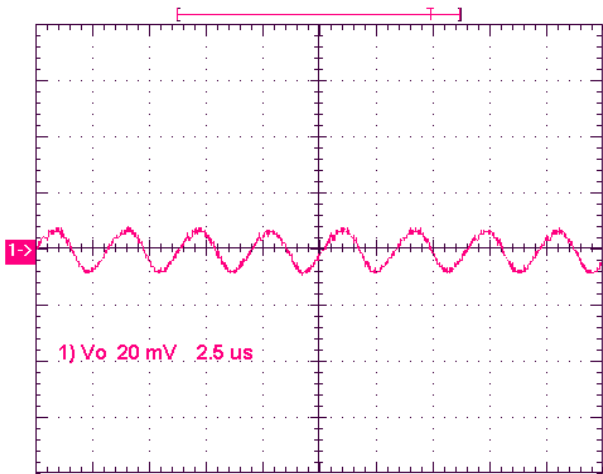

Noise $V_{IN}=5V$, $I_O=5A$, 5~20MHz Bandwidth

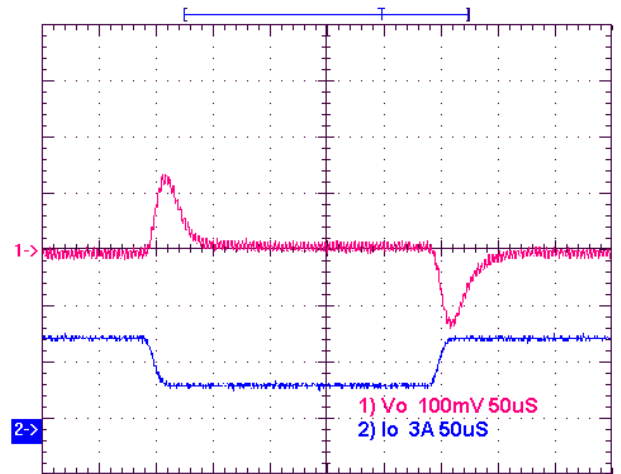

Transient Response $V_{IN}=5V$, Step from 5A~2.5A~5A

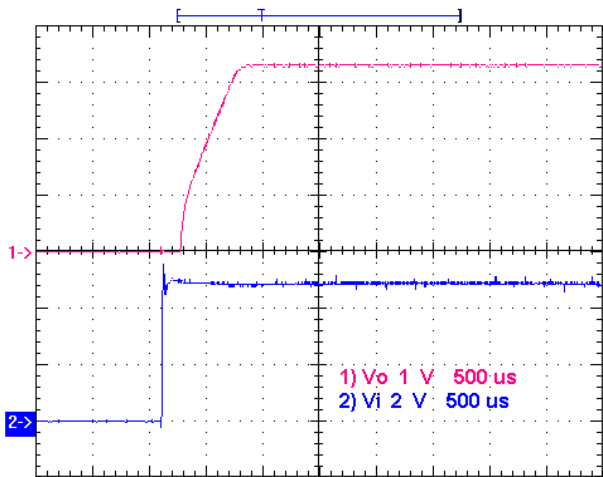

Start-up $V_{IN}=5V$, $I_O=5A$

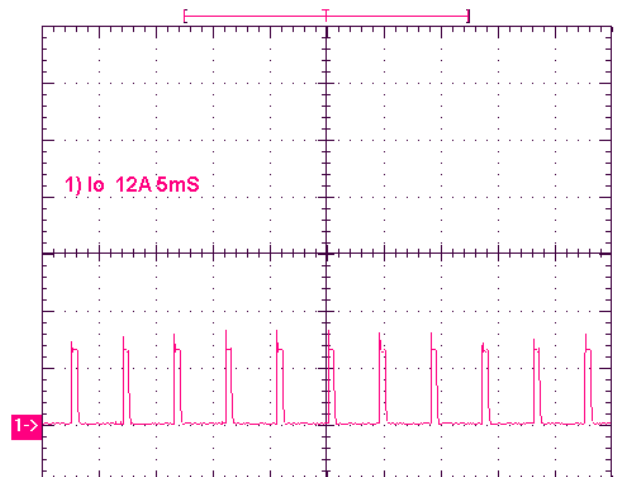

Short-Circuit Output $V_{IN}=5V$

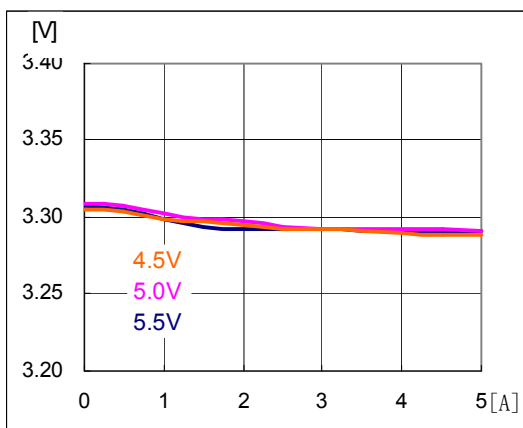

Regulation

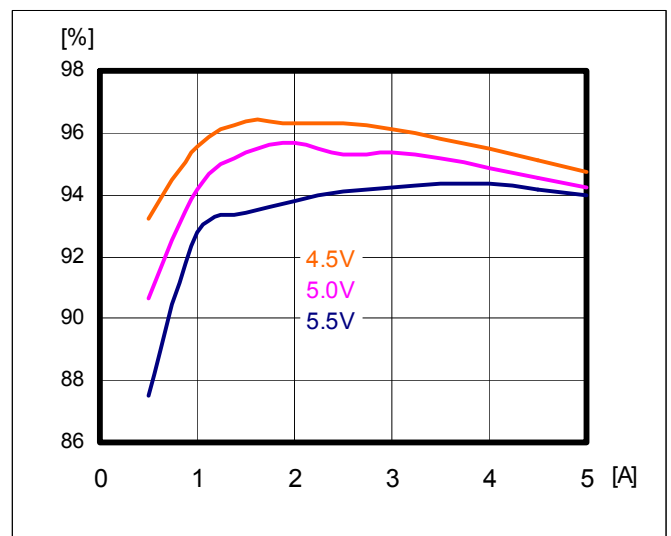

Efficiency

Output voltage vs. Load Current,

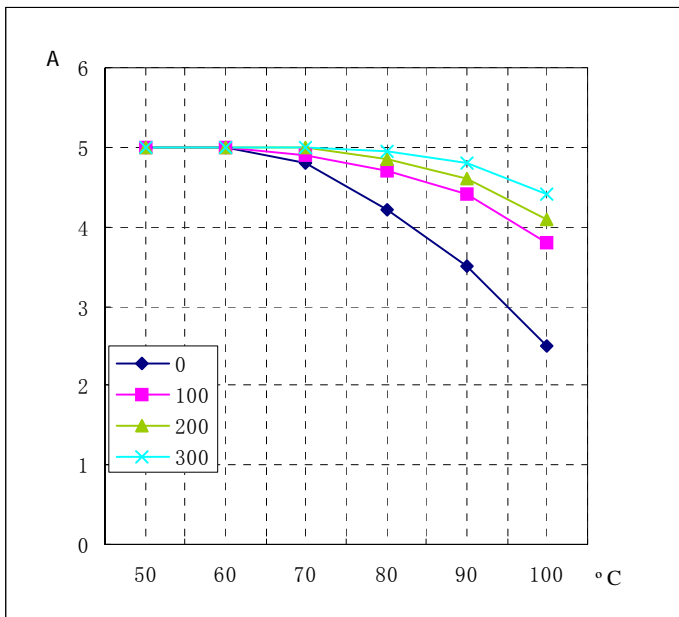

Output Current Derating (Load Current vs. Ambient Temperature), $V_{IN}=5V$,

Recommended Hole Pattern

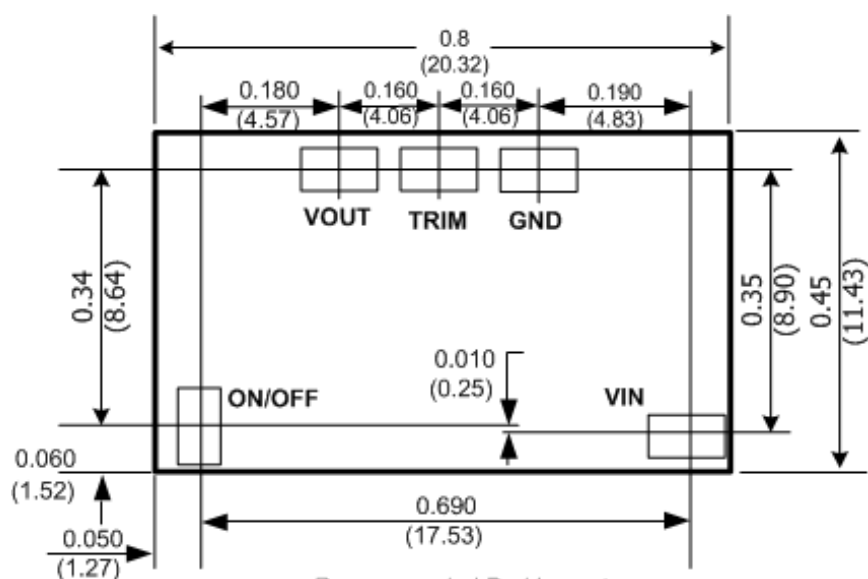

Recommended Pad Layout
Pad Size:
Min:0.120"x0.095"
Max:0.135"x0.110"

Component-side footprint for SMT Pin OUT

Application Notes